

Proceedings
of the Conference:
Communicative Problems
in Cleft Palate

DEPARTMENT OF COMMUNICATIVE DISORDERS
P. O. BOX 21, 790A
EAST TENNESSEE STATE UNIVERSITY
JOHNSON CITY, TN 37614

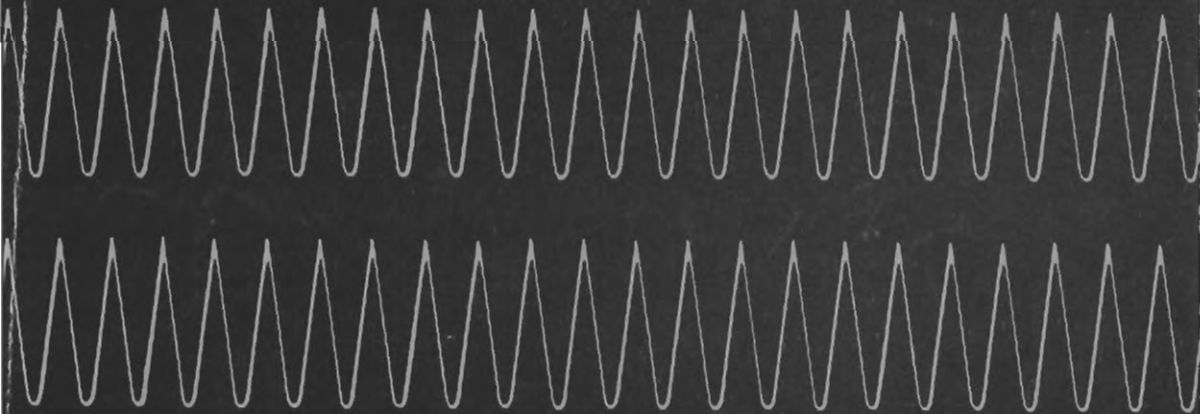

ASHA

REPORTS

NUMBER 1

A PUBLICATION OF THE AMERICAN SPEECH AND HEARING ASSOCIATION

**Proceedings of the Conference:
Communicative Problems in Cleft Palate**

July 10, 11, 12, 1963

This conference was supported by
Public Health Service Research Grant No. DE 01884-01
From the National Institute of Dental Research.

Conference Committee

John V. Irwin, Ph.D., Chairman

Kenneth Moll, Ph.D.

Lois A. Nelson, Ph.D.

Kenneth O. Johnson, Ph.D.

D. C. Spriestersbach, Ph.D.

NIDR Consultant to the Committee

Robert C. Likins, D.D.S.

ASHA Reports

Number 1

April 1965

The American
Speech and Hearing
Association

ASHA Reports
Number 1

OFFICERS

President

D. C. Spriestersbach, Ph.D.
University of Iowa

Past President

Hayes A. Newby, Ph.D.
Stanford University

Executive Vice President

John V. Irwin, Ph.D.
University of Wisconsin

Vice President

Mildred Templin, Ph.D.
University of Minnesota

Chairman Publications Board

Paul Moore, Ph.D.
University of Florida

OFFICERS ELECT

President Elect

William G. Hardy, Ph.D.
Johns Hopkins Medical Institute

Vice President Elect

Charlotte G. Wells, Ph.D.
University of Missouri

EXECUTIVE COUNCIL

Frederic L. Darley, Ph.D.
Robert Goldstein, Ph.D.
Arthur S. House, Ph.D.
John J. O'Neill, Ph.D.
Hildred Schuell, Ph.D.
Dean E. Williams, Ph.D.
Nancy E. Wood, Ph.D.
Phillip A. Yantis, Ph.D.

EXECUTIVE SECRETARY

Kenneth O. Johnson, Ph.D.

EDITORIAL ASSOCIATE

Diane Green

BUSINESS MANAGER

Kenneth O. Johnson, Ph.D.

ASHA PUBLICATIONS BOARD

Paul Moore, Ph.D., Chairman
John Black, Ph.D.
William G. Hardy, Ph.D.
Ira Hirsh, Ph.D.
James F. Jerger, Ph.D.
Kenneth O. Johnson, Ph.D.
Herold Lillywhite, Ph.D.
Maryjane Rees, Ph.D.
William Tiffany, Ph.D.

ASSISTANT TO EDITOR

Margaret S. Tokunaga

Proceedings of the Conference: Communicative Problems in Cleft Palate

CONTENTS

Introduction	<i>John V. Irwin</i> <i>J. Irwin</i>	1
Beyond Cleft Palate	<i>Jack Matthews</i> <i>D. H.</i>	3
Embryology, Anatomy, and Growth of Orofacial Complex	<i>Robert F. Hagerty</i> <i>R. H.</i>	5
Upper Respiratory Actions of the Infant	<i>James F. Bosma</i> <i>H. M. Truby</i> <i>John Lind</i> <i>Howell</i>	35
Dental Research – A Contemporary Viewpoint	<i>Edward J. Driscoll</i> <i>Hollifield</i>	51
The Techniques of Cleft Palate Surgery	<i>John Marquis Converse</i>	55
Audiological Problems Associated with Cleft Palate	<i>Claude S. Hayes</i> <i>Webb</i>	83
Other Concomitant Conditions: Other Physical Conditions	<i>Edward F. Lis</i> <i>Webb</i>	91
Psychosocial Aspects of Cleft Palate	<i>Grant T. Phipps</i> <i>Penley</i>	103
The Effects of Orofacial Anomalies on the Speech Process	<i>D. C. Spriestersbach</i> <i>Bloomfield</i>	111
Photographic and Radiographic Procedures in Speech Research	<i>Kenneth L. Moll</i> <i>Salo</i>	129
Air Flow and Air Pressure Studies	<i>James C. Hardy</i> <i>Howell</i>	141
Research Techniques and Instrumentation: EMG	<i>Franklin S. Cooper</i> <i>Hollifield</i>	153

INTRODUCTION

The Conference on Communicative Problems in Cleft Palate emphasizes certain common interests of the National Institute of Dental Research and the American Speech and Hearing Association. Although the National Institute of Dental Research is oriented to the profession of dentistry, its staff, under the leadership of the Director, Dr. Francis A. Arnold, is fully cognizant that many of its research goals must be multidisciplinary.

In this connection, the work of Dr. Earl Lyman, Associate Director for Extramural Programs, has been particularly important. Dr. Lyman has seen the relationship between dental research and cleft palate, and has provided impetus for the cleft palate programs of the National Institute of Dental Research.

In this Conference, the NIDR has offered more than financial support. Dr. Robert C. Likins, Chief, Extramural Programs Branch, gave generously of his time to the planning committee; Dr. Edward Driscoll, Clinical Director, was the luncheon speaker; and Dr. James Bosma, Chief, Oral and Pharyngeal Section, read a major paper.

I take pleasure in acknowledging the intent, counsel, and assistance of the National Institute of Dental Research and its staff in the planning and execution of this Conference.

John V. Irwin, Chairman
Conference Committee

BEYOND CLEFT PALATE

JACK MATTHEWS

University of Pittsburgh, Pittsburgh, Pennsylvania

This 3-day conference here in Washington will bring to the attention of professional workers in the field of communication disorders information which will result in providing better clinical services to individuals with cleft lips or palates. For such a contribution, the American Speech and Hearing Association (ASHA) is grateful to the National Institute of Dental Research (NIDR), our conference sponsor.

ASHA also is indebted to the NIDR for its sponsorship of an international symposium on Congenital Anomalies of the Face and Associated Structures in December 1959. That conference, often referred to as the Gatlinburg Conference, produced information which led to increased understanding of the etiology of cleft palate by workers in our field. It introduced many of us to the field of teratology.

Both conferences will reflect credit on NIDR. The information presented and the published proceedings will provide tangible evidence of the wise use of public monies. If nothing more than an exchange of information and this publication result from this conference, NIDR will have made a valuable contribution to our field.

I predict, however, that much more will take place. As specialists in dentistry and communication disorders meet during these few days, each will learn a great deal from the other. And, as ASHA Members and NIDR staff become better acquainted, we will see many reasons why it will be to our mutual advantage to further this acquaintance in the future.

In the past, the fields of communication disorders and dentistry have been largely clinical. Recently, both have begun to make real strides in strengthening their research activities at the basic and applied levels. ASHA Members are becoming increasingly aware of the contribution they can make to dentistry and of dentistry's contribution to the field of communication disorders.

To illustrate my point, at my own institution several of us in communication disorders hold joint appointments on the faculty of the School of Dentistry. For many years our course in anatomy of the speech mechanism was taught by the chairman of the Anatomy Department in the School of Dentistry. NIDR recently provided our University with a grant to establish a cleft palate

research center. This center came into existence as a result of joint efforts on the part of dentistry, plastic surgery, and the communication disorders section of the Speech Department.

Again, in my own institution, we can see another possible by-product which can come from this type of conference. I refer to a newly-established pre- and post-doctoral program which NIDR helped to establish for training specialists in communications research. Hopefully some of the people trained in this program will move into dental schools as teachers and researchers in the field of communication disorders. This cross fertilization between dentistry and communication disorders at Pittsburgh has resulted, I believe, in the training of better dentists and better communicologists. In turn, it has meant an improvement in the services both professions provide. Opportunities for cross fertilization to enrich our research efforts have long been apparent but are just beginning to materialize.

This is more than a conference on services for cleft palate. It is more than just a bringing together of speech and hearing specialists for several days to discuss communication problems in cleft palate. It is in the area of professional cross fertilization that I expect this conference will have its greatest impact. I hope that impact will go far beyond cleft palate. As one result, I hope more and more Members of ASHA will look to NIDR as an agency which can support worthwhile projects in our field. And, I hope this conference will serve to remind NIDR that there are clinicians, teachers, and research workers in the field of communication disorders who can contribute to that agency's over-all mission.

I predict this conference will have significant impact beyond the area of cleft palate: it will suggest new areas to explore in both dentistry and communication disorders.

The program of this conference reflects the careful planning which John Irwin and Kenneth Johnson of ASHA have carried out in conjunction with staff from NIDR.

EMBRYOLOGY, ANATOMY, AND GROWTH OF OROFACIAL COMPLEX

ROBERT F. HAGERTY, M. D.

Medical College of South Carolina, Charleston, South Carolina

In the time allotted we will attempt to look at some of the interesting features of embryology and anatomy about the mid-face and relate them to the cleft palate problem. The embryological study, both normal and pathological, will be taken almost entirely from Orban's works. Following this, the normal anatomy will be briefly reviewed and then some time spent on the pathological anatomy and growth.

DISCUSSION

Embryology

"During the second month of intrauterine life the critical changes occur that lead to the formation of the embryonic face, the nasal duct, the tongue, and finally, to the separation of oral from nasal cavities by the formation of the secondary palate. This period can, though diagrammatically, be divided into two phases. In the first phase that comprises the fifth and sixth weeks, the building blocks of the face are assembled, the communication of oral cavity with the foregut is established, and the nasal ducts are formed reaching from the primitive nostril to the primary choanae. At the end of this phase nasal cavities communicate widely with the oral cavity, on whose floor the tongue has developed.

"During the seventh week the preparations for the division of oral and nasal cavities are accomplished to culminate in the eighth week in the formation of the secondary palate. The seventh and eighth weeks thus can be regarded as the second phase in the formation of the basic components of the human face.

"The most frequent malformations of the face, namely 'harelip' and cleft palate, develop in this period. Roughly one could assume that failures of growth in the sixth week are most likely responsible for the cleft lip and alveolar process, while failures of growth in the eighth week cause the cleft palate. It is, however, probable, or at least possible, that disturbances of growth leading to the cleft of lip and alveolar process may disturb the further changes to such a degree that, secondarily, a cleft palate results. In other words, failure of formation of the primary palate may prevent the normal formation of the secondary palate.

FIGURE 1. Diagram of a median section through the head of a human embryo of 3 mm. length. Oral groove separated from foregut by a double layer of epithelium, the buccopharyngeal membrane. (Courtesy of the C. V. Mosby Company.)

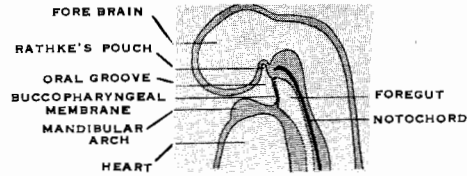

"In the human embryo, 3 mm in length (3 weeks old), the rounded prominence formed by the forebrain (prosencephalon, the anterior of the three primary brain vesicles) constitutes the greater part of the face. It is covered by the ectoderm and a thin layer of mesoderm (Figure 1). Below this rounded prominence there is a deep groove, the primary oral groove or stomatodeum. Its caudal boundary is the first branchial arch or mandibular arch. Its lateral boundaries are formed by the maxillary processes which arise from the posterolateral ends of the mandibular arch, and are directed upward and slightly anteriorly. In early stages, the mandibular arch consists of three parts. On either side a smooth bulge protrudes on the lateral and anterior surfaces of the embryonic head. They are united at the midline by the copula (Figure 2, A).

"The oral groove lined by ectoderm extends inward to meet the blind cranial end of the foregut. Here, the entodermal gut and ectodermal oral groove are separated by a double layer of epithelium, the buccopharyngeal membrane (Figure 1). Anterior to the cranial end of this membrane the primordium of the anterior lobe of the hypophysis develops as a shallow ectodermal pouch: Rathke's pouch. Rupture of the buccopharyngeal membrane, which occurs when the embryo is about 3 mm long, establishes the communication between the oral cavity and the foregut.

"The first significant change in the development of the face is caused by rapid proliferation of the mesoderm which covers the anterior end of the brain, and a broad prominence is formed between the two maxillary processes (Figure 2, B). This prominence constitutes the middle part of the upper face and is known as the frontonasal process. The next stage is the formation of shallow and ever deepening oral grooves, olfactory (nasal) pits, which divide the caudal part of the frontonasal process into a single middle and two smaller lateral nasal processes (Figure 2, C). The lateral nasal processes are adjacent to the maxillary processes, and are separated from them by shallow furrows, running upward and laterally. These furrows are the nasomaxillary groove, which was formerly called the nasolacrimal groove, but it now is known that this groove has no relation to the development of the nasolacrimal duct. The nasolacrimal duct begins its development with the formation of an epithelial ingrowth, along a line parallel with, but medial to, the nasomaxillary groove (Figure 3).

"The medial nasal process grows downward more rapidly than the lateral nasal processes. Its rounded and prominent inferolateral corners are known

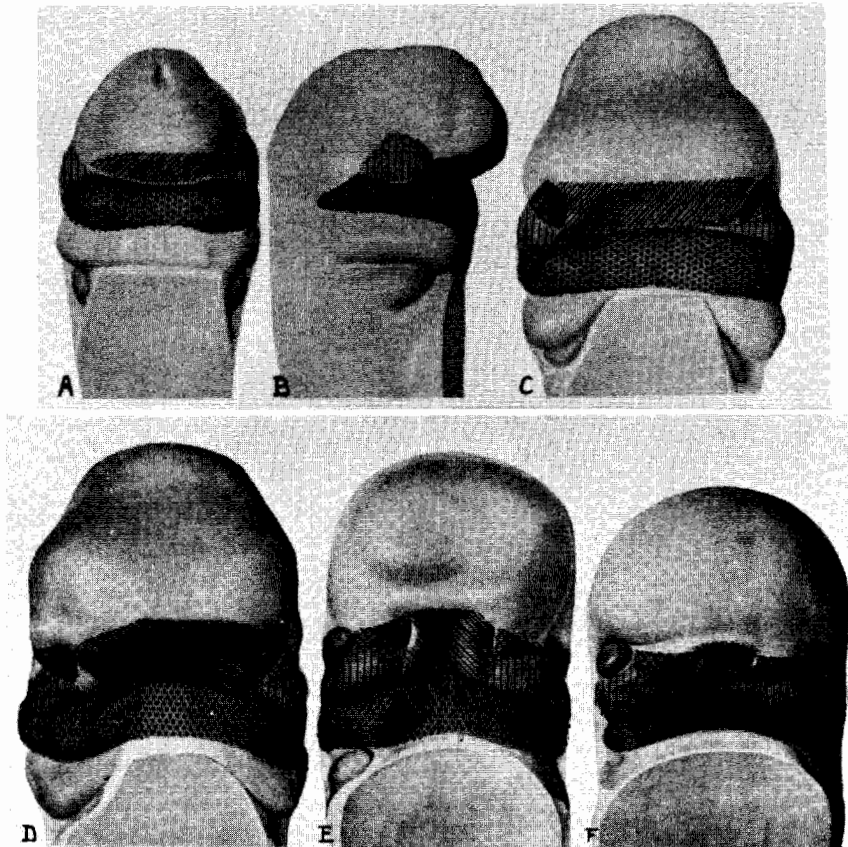

FIGURE 2.—Development of the human face.

A and B, Embryo 3 mm. long, 3rd week: Frontonasal process (diagonal lines) undivided. Caudal to mandibular arch (dots), the hyoid arch and the third branchial arch. Depression on top of figure is neuropore.

C, Embryo 6.5 mm. long, 4th week: Nasal pits divide the frontonasal process into medial nasal process (diagonal lines) and lateral nasal processes (cross-hatching).

D, Embryo 9 mm. long, 5th week: Fusion of medial nasal and maxillary processes has narrowed entrance into nasal pit.

E, Embryo 9.2 mm. long, 6th week: Fusion of medial and lateral nasal processes has further narrowed the nostrils. Medial nasal process reduced in relative width. Eyes at lateral edges of face.

F, Embryo 14.5 mm. long, 7th week: Nasal area slightly prominent. Nasal septum further reduced in relative width. Eyes on anterior surface of face.

as the globular processes (Figure 2, C and D). Later, the globular processes come in contact with the forward growing maxillary processes on both sides but no fusion occurs at this site. Therefore, the lateral nasal processes do not take part in bounding the entrance into the oral cavity.

“The subsequent changes are only partly due to fusion of primarily separated ‘processes’. A fusion takes place only during formation of the

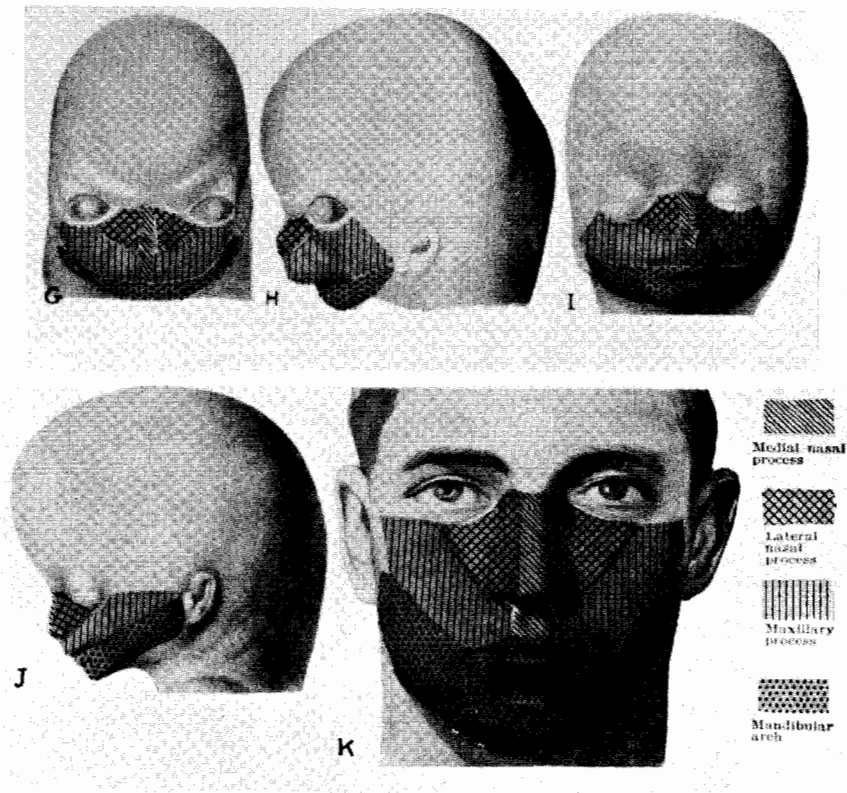

FIGURE 2. *Continued.*

G and H, Embryo 18 mm. long, 8th week: Lidless eyes on anterior surface of face. Their distance relatively reduced, mandible short.

I and J, Embryo 60 mm. long, 12th week; Lids closed. Nostrils closed by epithelial proliferation. Relation of mandible to maxilla normal.

K, Adult face: The derivatives of medial nasal process (diagonal lines), lateral nasal processes (cross-hatching), maxillary processes (vertical lines), and mandibular arch (dots). Modified after Sicher and Tandler.¹⁰ (Courtesy of the C. V. Mosby Company.)

primary palate and, to some extent, during the later stages in the development of the mandible. In all other regions the grooves separating the facial processes gradually become shallow by proliferation of the mesoderm, and finally disappear. The first step in this critical phase is the elevation of the margins of the olfactory pit along their inferior or caudal half (Figure 4, A and A'). The rims are formed medially by the medial nasal process and laterally by the lateral nasal process and the maxillary process. When the margins of the pit grow higher, they also grow toward each other, and finally the epithelial covering of the 'lips' touch each other and fuse (Figure 4, B). The wide open nasal pit is thus transformed into a blind ending sac, accessible through the cranial part of the original opening, that now can be called the primary nostril.

MAXILLARY
PROCESS
MANDIBULAR
ARCH
HYOID ARCH



EYE
NASOLACRIMAL
GROOVE
NASOMAXILLARY
GROOVE

FIGURE 3. Photograph of human embryo of 10 mm. length. Nasomaxillary and nasolacrimal grooves. (Courtesy Dr. P. Gruenwald.) Courtesy of the C. V. Mosby Company.

“At this time the blind end of the nasal sac corresponds to a point on the embryonic face, just above the oral orifice. Were this blind end to open now, the nasal duct would open in the face instead of into the oral cavity. Therefore, a change in the topographic relations of the nasal sac precedes the final stages (compare B¹ and C¹ of Figure 4). This change is effected by differential growth, by a bulging of the mesoderm along a line through the blind part of the nasal sac and parallel to the oral orifice, and by a simultaneous forward growth of the mandibular arch. The formerly flat surface above the oral fissure becomes convex with the upper part remaining in the general plane

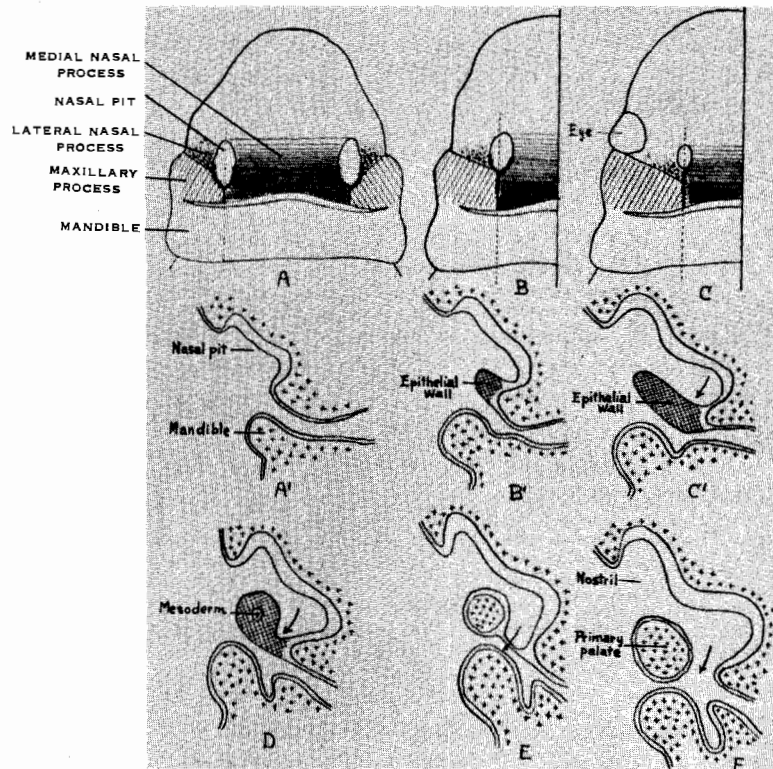

FIGURE 4. Six stages in the development of the primary palate (diagrams).
A and A', Face of a human embryo of 6.5 mm length (compare Fig. 2, C). The zig-zag line on the inferior border of the nasal pit marks the line of later fusion of medial nasal

process to maxillary and lateral nasal processes. The broken line marks the plane of section A'.

B and B', Human embryo of 9 mm length (compare Fig. 2, D). The medial nasal process has fused with the maxillary process. By this fusion an epithelial wall has been formed which is visible in section B'. The nasal pit is closed in its inferior part to form a short blind olfactory sac.

C and C', Human embryo, 9.5 mm in length (compare Fig. 2, E). The medial nasal process is now fused to maxillary and lateral nasal processes. The epithelial wall has lengthened (C'). The arrow in C' points to the area in which the epithelial wall separates olfactory sac from oral cavity.

D, Human embryo of 12 mm length. The plane of section is as in Figs. A', B', and C'. The mesoderm has broken through the superior part of the epithelial wall thus strengthening the primarily epithelial fusion of medial nasal process to maxillary and lateral nasal processes. The inferior part of the epithelial wall has thinned out (arrow).

E, Human embryo of 14 mm length. The destruction of the superior part of the epithelial wall by proliferating mesoderm (crosses) has advanced. The inferior part of the epithelial wall is thinned out to form the nasobuccal membrane (arrow).

F, Human embryo of 15 mm length. The nasobuccal membrane has disappeared. Nasal cavity communicates with oral cavity through the primary choana (arrow). The superior part of the epithelial wall is entirely replaced by proliferating mesoderm forming the primary palate between nasal and oral cavities.

A', B', C', D, E, and F represent sagittal sections corresponding to the broken lines in A, B, and C and comparable sections of the three older embryos. (Courtesy of the C. V. Mosby Company.)

of the face, while the lower part is shifted into a horizontal plane, and forms the anterior part of the roof of the oral cavity. The blind end of the sac now faces the roof of the primary oral cavity.

"At this time the lateral and medial lips of the olfactory pit are joined merely by their fused epithelial coverings, the epithelial wall. This epithelial lamella is now destroyed by proliferating mesoderm (Figure 4, D and E) so that the junction becomes permanent. However, the epithelium at the blind end persists and is stretched and thinned out by the growth of the surrounding parts. Finally it develops into a thin membrane, the nasobuccal membrane (Figure 4, E) separating the blind end of the nasal sac from the oral cavity, and when this membrane ruptures the nasal sac becomes the nasal duct leading from an outer facial opening, the primary nostril, to an inner oral opening, the primary choana (Figure 4, F).

"The horizontal bar, formed by the fusion of the medial nasal processes with the lateral nasal and maxillary processes, separates the nasal duct from the oral cavity. It is called the primary palate. From this tissue will develop the upper lip and the anterior part of the maxillary alveolar process.

"The formation of the primary palate is accomplished at the end of the sixth week of embryonic life, when the embryo is approximately 10 to 11 mm long.

"While the primary palate is formed, the mandibular arch undergoes some changes that lead to the temporary appearance of a median furrow and a small pit on either side of the midline. These pits seem to disappear by a fusion of their walls.

"Further development can be explained briefly by differential growth of the regions of the embryonic face (Figure 2). The most important change is



FIGURE 5. Reconstruction of the roof of the primitive oral and pharyngeal cavities of a human embryo of 23 mm. length (eighth week). Primary palate and internal surface of maxillary process form a horse-shoe-shaped and incomplete roof of the oral cavity. In the center the oral cavity communicates with the nasal cavity. At the edges of maxillary processes the palatine processes develop. (Sicher and Tandler.¹⁰) Courtesy of the C. V. Mosby Company.

caused by the fact that the derivatives of the medial nasal process grow more slowly in breadth than those of the lateral nasal and maxillary processes. On the other hand, the middle region of the face between the eyes increases in an anterior direction and, thus, bulges over the surface of the face. Thereby, the external nose is formed and, at the same time, the eyes, first situated on the lateral surface of the head, come to lie on the anterior surface (Figure 2, E, F, and G). The outer nasal openings are temporarily closed by proliferating epithelium, as are the openings of the eyes after development of the lids (Figure 2, I and J).

"The nose, even in a newborn infant, is not yet fully developed. This is illustrated by the fact that all children are born with a deeply saddled snub nose. Only at the time of puberty does the nose develop to its inherited size and shape.

"The growth of the mandible follows a peculiar curve. At first it is small as compared with the maxilla; the growth in length and width shows a spurt

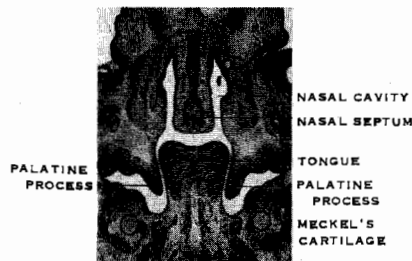
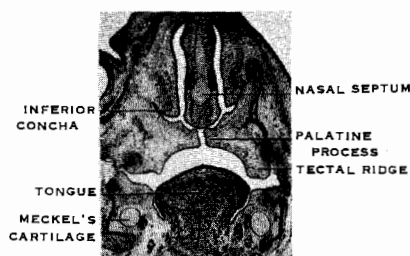

FIGURE 6. Frontal section through the head of a human embryo of 24 mm. length (eighth week). Tongue high and narrow between the vertical palatine processes. (Courtesy Dr. P. Gruenwald.) Courtesy of the C. V. Mosby Company.

coinciding with a certain stage in the development of the palate. Later, the mandible again lags in growth behind the maxilla (Figure 2, G and H). A fetus of 2 to 3 months still shows a physiological micrognathism which disappears before birth. The oral opening is, at first, very wide. In the lateral area the upper and lower lips fuse to form the cheeks and, thereby, the width of the mouth is considerably narrowed.

"When the primary palate is formed the primary nasal cavity is a short duct leading from the nostril into the primitive oral cavity. Its outer and

FIGURE 7. Frontal section through the head of a human embryo of 30 mm. length (ninth week). Tongue has evacuated the space between the palatine processes and lies flat and wide within the mandibular arch. The palatine processes have assumed a horizontal position. (Courtesy Dr. P. Gruenwald.) Courtesy of the C. V. Mosby Company.



inner openings (primary choanae) are separated by the primary palate (Figure 4) which develops into the upper lip, the anterior part of the alveolar process, and the premaxillary part of the secondary palate.

“When the primitive oral cavity increases in height, the tissue separating the two primitive choanae grows back and down to form the future nasal

FIGURE 8. Frontal section through the head of a human embryo slightly older than that in Fig. 7. The horizontal palatine processes have fused with each other and with the nasal septum. Secondary palate separates nasal from oral cavities. (Courtesy of the C. V. Mosby Company.)

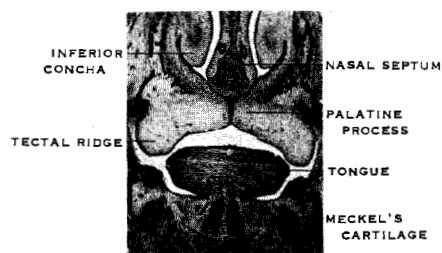

septum. At this stage, the oral cavity communicates freely with the nasal cavities. The oral cavity has an incomplete horseshoe-shaped roof formed anteriorly by the primary palate and laterally by the inner horizontal surface of the maxillary processes (Figure 5). In the middle the oral cavity communicates with the nasal cavities to the left and right of the nasal septum (Figure 6).

“Folds develop where the lateral part of the oral roof bends sharply into the vertical lateral wall of the nasal cavity. They grow downward almost vertically and lie to each side of the tongue which, in cross section, is high and touches the inferior edge of the nasal septum (Figure 6). This vertical process, the posterior end of which can be traced to the lateral walls of the pharynx, is the palatine process (Figures 5 and 6).

“The secondary palate which separates oral and nasal cavities is formed by a fusion of the palatine processes, after they have changed from a vertical to a horizontal position (Figure 7). The anterior parts of the palatine processes fuse not only with each other but also with the inferior edge of the nasal septum (Figure 8). In this area the hard palate develops. The posterior parts of the palatine processes which form soft palate and uvula have no relation to the nasal septum.

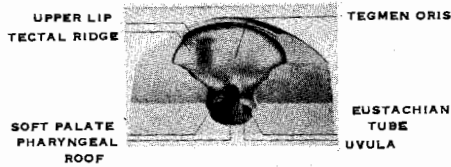

FIGURE 9. Reconstruction of palate of a human embryo of 28.5 mm. length. The palatine processes fused in the area of the hard palate. The fusion has not reached the soft palate and uvula. (Sicher and Tandler.¹⁰) Courtesy of the C. V. Mosby Company.

“The transposition of the palatine processes can occur only when the tongue has moved down and thereby has evacuated the space between these processes. This is made possible by a sudden growth of the mandibular arch in length and width, at this time. The growth of the mandible is accelerated to such an extent that a mandibular protrusion can be observed. The tongue drops into the wide arch of the mandible and assumes its natural shape, with its transverse diameter larger than its vertical (compare Figure 6 with Figures 7 and 8). The transposition of the palatine processes is brought about by differential growth. The mesodermal cells are densely grouped on the oral (lateral) surface of the vertical palatine processes, especially at the angle between the process itself and the lateral part of the oral roof (Figure 6). The dense arrangement of the cells and the presence of mitoses prove this area to be one of rapid proliferation. In other words, the oral surface of the fold grows more rapidly than the nasal; this, necessarily, leads to a rapid change in the position of the fold away from the faster growing side. Thus, the palatine processes turn into a horizontal position immediately after the tongue has evacuated the space between them.

“When the palatine processes have assumed their horizontal position, they touch the lower border of the nasal septum, but are still separated from each other by a median cleft (Figure 7) which widens posteriorly. The cleft closes gradually in an anterior-posterior direction. At first an epithelial suture can be observed between the palatine processes and between those and the nasal septum (Figure 8). Later, this epithelial wall is perforated and broken up by growing mesoderm; remnants of the epithelium may persist as epithelial pearls. The epithelium remains only at the anterior end where the palatine processes fuse with and partly overgrow the primitive palate on its oral side. Here, the epithelium forms two strands, beginning in the nasal cavity and uniting below the septum to connect with the oral epithelium. They are the primordium of the nasopalatine ducts, vestigial in man.

“It has to be stressed that the entire palate does not develop from the palatine processes. They give rise only to the soft palate and the central part of the hard palate. This portion of the hard palate, termed the tegmen oris, is surrounded by a horseshoe-shaped prominence, the tectal ridge (Figure 9).

“The palate is separated from the lip by a shallow sulcus. From its depth two epithelial laminae arise: an outer vestibular and an inner dental lamina. Later, the alveolar process forms from the mesoderm between these laminae.

“The palatine papilla develops very early as a round prominence in the anterior part of the palate. Irregular transverse folds, the palatine rugae, cross

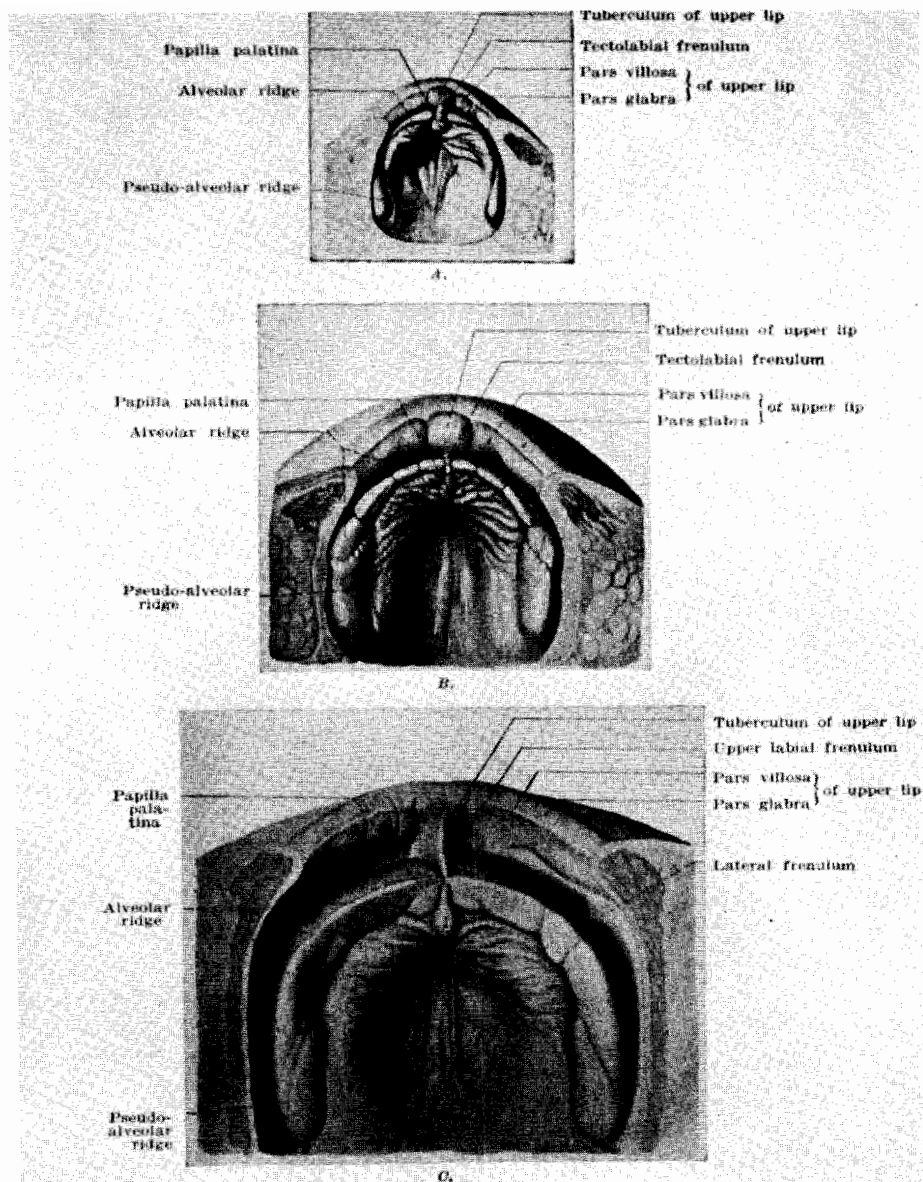

FIGURE 10. Advanced stages in the development of the hard palate. A, Human fetus, 3 months old. B, Human fetus, 4 months old. C, Human newborn infant. Note the changes in the relationship of palatine papilla and frenulum and those between the alveolar ridge and pseudo-alveolar ridge. (Sicher and Tandler.¹⁰) Courtesy of the C. V. Mosby Company.

the palate in its anterior part. At this stage the lips show a definite division into an outer smooth zone, pars glabra, and an inner zone, beset with fine villi, pars villosa. In the upper lip the middle part of this inner zone is prominent,

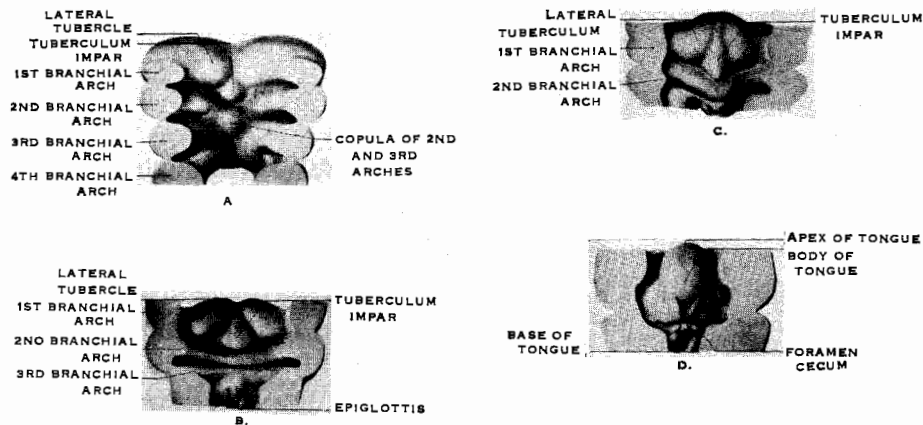

FIGURE 11. Development of the tongue. Anterior wall of pharynx and floor of the oral cavity seen from within.
 A, Human embryo of 3.5 mm. length (third week).
 B, Human embryo of 6.5 mm. length (fourth week).
 C, Human embryo of 8 mm. length (fifth week).
 D, Human embryo of 11 mm. length (sixth week). (Sicher and Tandler.¹⁰ Courtesy of the C. V. Mosby Company.)

forming the tubercle of the upper lip. A fold connects the palatine papilla with this tubercle: the tectolabial frenulum (Figure 10, A and B).

"When, in later stages, the growing alveolar process bulges between palate and lip, the tectolabial frenulum is separated from the palatine papilla and persists as the upper labial frenulum, connecting the anterior surface of the alveolar ridge with the upper lip (Figure 10, C).

"The development of the maxillary alveolar ridges is complicated by the appearance of a bulge in the molar region which may be easily confused with the alveolar process. It has been called the pseudo-alveolar ridge and disappears gradually when the alveolar process expands posteriorly (Figure 10).

"The development of the alveolar ridge in the mandible is simple. No pseudo-alveolar ridge is present and the alveolar process bulges gradually into the oral cavity, inside the labial sulcus. The labial sulci open up and form the oral vestibule which extends posteriorly into the region of the cheeks.

"Before describing the development of the tongue a few words should be said about the development of the branchial arches (Figure 2). A prominence similar to the mandibular or first branchial arch develops parallel and caudal to it. This, the second or hyoid arch, is separated from the first by a sharp and deep furrow. Caudal to the second branchial arch a third, fourth, and fifth develop, each smaller and less prominent than the preceding. The last three arches do not reach the surface at the midline but are confined to the lateral region of the neck.

"The furrows which separate the arches on the outer surface are the

branchial grooves. Corresponding deep furrows develop as lateral pockets on the pharyngeal wall; these are the pharyngeal pouches (Figure 11, A).

"The epithelium of the pharyngeal pouches gives rise by complicated processes to a variety of organs. From the first pouch are derived the auditory tube and the cavities of the middle ear. In the region of the second pouch the palatine tonsil is laid down. The third gives rise to one parathyroid gland and the thymus; the fourth to the second parathyroid and the ultimo-branchial body.

"On the outside the third, fourth, and fifth arches are over-grown by a caudal outgrowth of the second arch, the operculum (Figure 2, C). Thus, the third, fourth, and fifth arches are placed in a deep recess, the cervical sinus. Later, this is closed by fusion of the operculum with the lateral wall of the neck. The cavity of the recess is soon obliterated, although remnants may give rise to branchial or cervical cysts.

"The tongue is derived from the first, second, and the third branchial arches. The dividing line between the derivatives of the first and the more caudal arches is marked throughout life by the terminal sulcus in the area of the vallate papillae. The body and apex of the tongue originate as three prominences on the oral aspect of the mandibular arch (Figure 11, A, B, and C). The lateral lingual prominences are two in number, one on each side; the third, unpaired, appears between these two and somewhat posteriorly; it is the tuberculum impar. The base of the tongue develops later as a bulge on the middle part (copula) of the second and third arches. The unpaired tubercle, prominent and large at first, is soon reduced in relative size (Figure 11, C) and, later, almost disappears (Figure 11, D).

"In the midline, between the derivatives of the first and second arches which contribute to the development of the tongue, the thyroid anlage develops. This gives rise to the thyroid gland by progressive downward growth. The beginning of the transitory thyroglossal duct is marked by the foramen cecum of the tongue which persists in the adult. In this region thyroglossal duct cysts may develop.

"The later stages of tongue development are characterized by a mushroom-like growth of the organ, and by gradual differentiation of the various lingual papillae. The skeletal (extrinsic) muscles of the tongue grow into its mesodermal primordium; the intrinsic muscles differentiate in situ from the mesenchyme of the tongue.

"The described development of the tongue explains two malformations. A lack of fusion between the two lateral mandibular tubercles may cause a bifid tongue. A persistence of the tuberculum impar is said to be the cause for the rhomboid glossitis.

"The most frequent malformations of the face are known as clefts. Clefts of the lip, jaw, or palate may occur once in about eight hundred births. The complete harelip is a cleft, lateral to the midline, cutting through the upper lip and continuing as cleft jaw or gnathoschisis through the anterior part of

the alveolar process. It may be unilateral or bilateral. The cleft palate may be unilateral or bilateral, complete or partial, involving the uvula only or extending into the soft and hard palate. The oblique facial cleft is a defect which begins in the upper lip and can be traced through the nostril, or lateral to it, over the cheek to the eye. More or less deep pits in the lower lip not far from the midline, on one or both sides, are known as labial fistulae.

"In its complete form the harelip and cleft jaw is a cleft which extends from the lower border to the nostril, lateral to the midline, through the upper lip and upper alveolar process, to the region of the foramen incisivum. In the past, the development of this malformation was attributed to a lack of fusion of the medial nasal process with the lateral nasal, and the maxillary process. However, recent investigations have revealed that an epithelial fusion does occur in cases of harelip but that the epithelial wall is not perforated by mesoderm. Therefore, the epithelial union of these processes ruptures. This explanation is borne out by the occurrence of thin strands of tissue which unite, in some cases, the medial and lateral walls of the harelip. These bridges develop if the mesoderm perforates the epithelial wall only in a restricted area. Harelip and cleft jaw would be evident at 6 to 7 weeks in utero.

"The relation of cleft jaw to the bone and to the teeth varies considerably. In some cases the cleft corresponds to the suture between premaxilla and maxilla; in other cases the cleft cuts through the premaxilla itself, dividing it into a medial and a lateral part. Frequently, the lateral incisor is found medial to the cleft jaw, in some cases lateral to it. The lateral incisor is, in some instances, medial to the harelip, and a supernumerary lateral incisor lies lateral to it. In other cases the lateral incisor is missing. The explanation for this variability is that the skeletal parts appear long after fusion of the facial processes has been completed. Thus, the bones develop in a uniform tissue and with no regard for the primary boundaries between the processes.

"The dental lamina, the matrix of the tooth germs, is likewise independent of the facial processes. Harelip and cleft jaw occur in the general region of the lateral incisor. In some cases, it may cut the matrix medially or laterally to the prospective primordium of the lateral incisor, or it may go right through it. In the lateral cases by a process of regeneration, each part of the divided primordium may produce a complete lateral incisor or, on the other hand, the development of the lateral incisor may be suppressed altogether.

"Cleft palate results from a lack of fusion of the palatine processes, with each other and the nasal septum. In unilateral defects one process fuses with the lower border of the septum so that one nasal cavity is completely separated from the oral cavity. Palatal fusion is usually completed at the end of the fourth month in utero.

"The fusion of the palatine processes commences at their anterior ends and proceeds backward. The process of fusion may be interrupted at any time. This explains the different types of cleft palate. The cleft may be limited

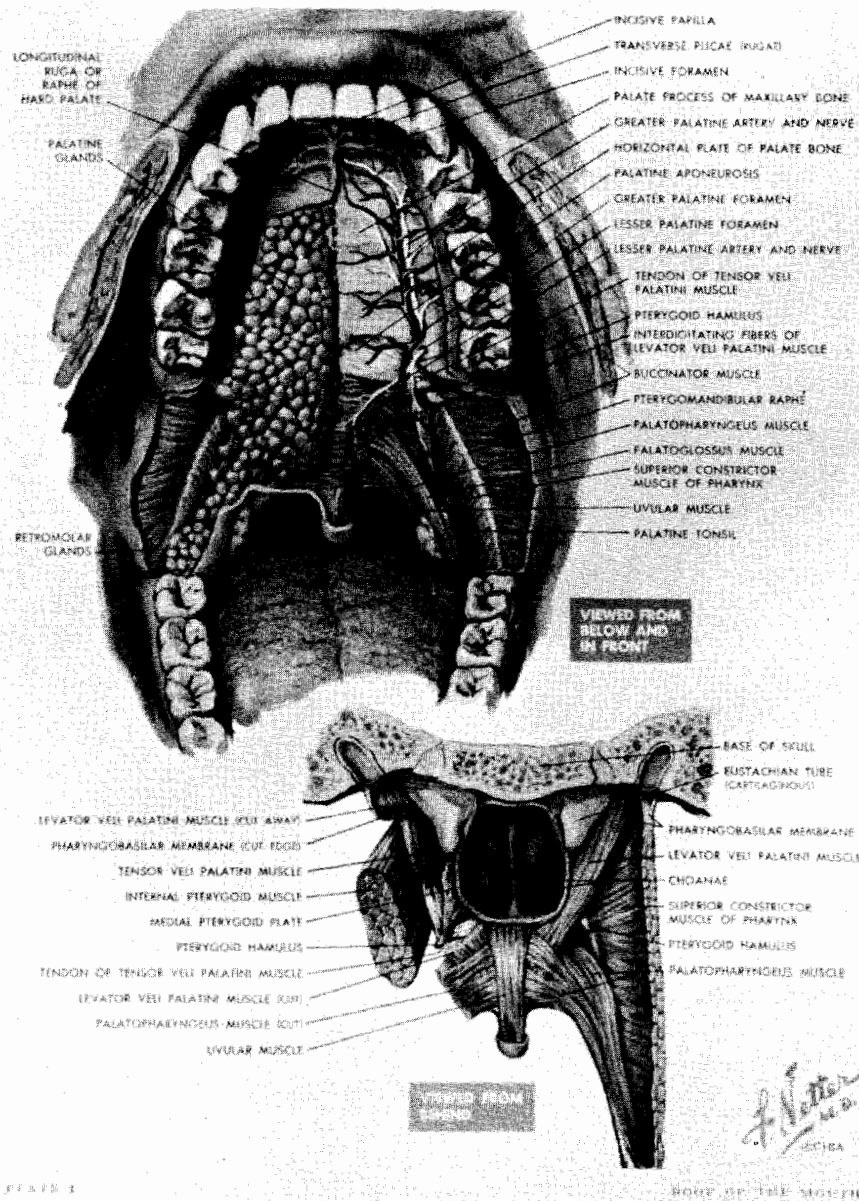

FIGURE 12. The anatomy of the roof of the mouth. Courtesy of Dr. J. F. Huber.

to the uvula, may extend through a portion of or the entire soft palate, or may involve parts of or the entire hard palate.

“Cleft palate is frequently (84 per cent) associated with a unilateral or bilateral harelip. In the latter case the tissues between the two clefts are, sometimes, protruding as a knoblike growth in the midline, whereas in other cases

the tissues may fail to grow. The latter results in the formation of the so-called false median cleft of the upper lip.

"Heredity probably is the major etiologic factor in clefts of the face, lip, jaw, and palate. Members of one family sometimes show, in addition to or instead of harelip, the so-called fistula of the lower lip. This tends to show that these fistulae develop from causes similar to those responsible for harelip. In these cases, the pits between the medial and lateral parts of the mandibular arch remain open and even enlarge."¹

Anatomy

Since it would require several hours to review the anatomy of the midface, we will concentrate on the palate and lips. The reports of the anatomist, Dr. John Huber, will be followed.

"The palate, or roof of the mouth (Figure 12) forms the superior and posterosuperior boundaries of the oral cavity, thus separating it from the nasal cavity and nasopharynx. The anterior two-thirds of the palate had a bony framework and is thus called the 'hard palate'. The posterior third, being a musculotendinous organ, is called the 'soft palate'. The palate is variably arched both anteroposteriorly and transversely, the transverse curve being more pronounced in the anterior portion.

"The bony framework of the hard palate is formed by the palatine processes of the two maxillae and the horizontal processes of the two palatine bones. These bony structures also form the framework of the floor of the nasal cavity. This common bony wall is traversed near the midline anteriorly by the incisive canals, which transmit blood vessels and nerves from the mucous membrane of the nose to the mucous membrane of the roof of the mouth.

"Usually one canal begins at each side of the midline on the upper or nasal side of the palate. Each of these canals then divides into two before reaching the oral side, where all four resulting canals open into a single midline fossa, the incisive foramen. Near the posterolateral angles of the palate, on each side are located the greater and lesser palatine foramina for the transmission of the greater and lesser palatine vessels and nerves.

"The oral surface of the bony palate is covered by mucoperiosteum (fused mucous membrane and periosteum). In the midline is a slight ridge, the palatine raphe, at the anterior end of which is a small elevation called the incisive papilla. Running laterally from the anterior part of the raphe are about six transverse ridges, the transverse plicae or rugae.

"The soft palate is continuous anteriorly with the hard palate. It ends postero-inferiorly in a free margin, which forms an arch with the palatoglossal and the palato-pharyngeal folds on each side as its pillars. The uvula, greatly variable as to length and shape, hangs from the center of the free margin of the soft palate.

¹From *Oral Histology and Embryology* (4th Edit.) by B. J. Orban, courtesy of The C. V. Mosby Co., St. Louis.

"The framework of the soft palate is formed by a strong, thin fibrous sheet, known as the palatine aponeurosis, which is, at least in part, formed by the spread out tendons of the tensor veli palatini muscles. In addition to the aponeurosis, the thickness of the soft palate is made up of the palatine muscles, many mucous glands on the oral side, with mucous membrane on both the oral and pharyngeal surfaces. The mass of glands extends forward onto the hard palate as far anteriorly as a line between the canine teeth.

"The muscles of the soft palate can be briefly described as follows:

- (1) The levator veli palatini arises from the posteromedial side of the cartilaginous portion of the auditory tube and the adjacent lower surface of the petrous portion of the temporal bone. Its anterior fibers insert in the palatine aponeurosis, while the posterior ones are continuous with those of the opposite side.
- (2) The tensor veli palatini arises from the anterolateral side of the cartilaginous portion of the auditory tube and the adjacent angular spine as well as the scaphoid fossa. It inserts by a tendon which passes around the pterygoid hamulus and then spreads out into the palatine aponeurosis.
- (3) The uvular muscle arises from the posterior nasal spine and palatine aponeurosis. It unites with the same muscle of the other side to end in the mucous membrane of the uvula.
- (4) The palatoglossus muscle runs from the soft palate to the side of the tongue, forming the anterior faucial pillar.
- (5) The palatopharyngeus muscle runs from the posterior portion of the soft palate downward and backward into the pharyngeal wall, thus forming the posterior pillars of fauces.

"Except for the tensor veli palatini, which is supplied by the trigeminal nerve, these muscles are supplied by the vagus nerve by fibers from the cranial part of the spinal accessory nerve.

The soft palate can be positioned as necessary for swallowing, breathing, and phonation by the muscles that have been described. It can be brought into contact with the dorsum of the tongue, and it can be brought backward and upward against the wall of the pharynx to close off the nasopharynx during swallowing.

"The framework of the cheek (Figure 13) is formed by the buccinator muscle, which takes its origin from the outer surfaces of the maxilla and mandible in the region of the molar teeth. Between the posterior ends of these lines of attachment, the muscle is attached to the pterygomandibular raphe, by which it is continuous with the superior constrictor of the pharynx. From this origin the fibers of the muscle run horizontally forward to continue into the orbicularis oris muscle. The uppermost and lowermost fibers run into the upper and lower lips respectively. The intermediate fibers cross near the corner of the mouth, so that the upper fibers of this intermediate group go



FIGURE 13. The nerve supply of the mouth and pharynx. Courtesy of Dr. J. F. Huber.

into the lower lip, and the lower fibers go into the upper lip. The buccinator muscle is supplied by a branch from the facial nerve.

“The framework of the lips is formed by the orbicularis oris muscle. In addition to the fibers which appear to be forward prolongations of the buccinator muscle, fibers come into the orbicularis oris from all of the muscles

which are inserted in the vicinity. The orbicularis oris muscle is also supplied by the facial nerve."²

It can thus be seen that there is a circular or oval continuity of the musculature of the lips, cheeks, and pharynx acting with a compressing effect on the maxillary and palatal structures. This is of basic importance if we are to understand the interplay of these forces in growth. We will review this aspect of the problem in some detail in order to have some appreciation of the development of the pathological anatomy.

Growth

"Orthodontists have long been aware that abnormal or unbalanced muscular influences are capable of producing significant alterations of the facial skeleton and serious disturbances of the dental occlusal relationship. Over 120 years ago Rodrigues called attention to the role of altered muscular function in the production of malocclusion. Undoubtedly he and others had recognized this principle some years prior to the publication of his short article in 1840. Lefoulon in 1841 described irregularities of the teeth produced by repeated action of the tongue in the pronunciation of lingual syllables. In his book, published in 1843, Desirabode commented on displacement of secondary incisors and canines:

'It must not be supposed that any great force is necessary for this purpose; it only requires a slight default of antagonism between two powers in the midst of which the teeth are placed, that is to say, between the lips in front and the tongue behind. Do we not perceive that, in almost all cases of hare lip, the teeth corresponding to the fissure throw themselves forward; and that the operation which corrects this deformity also replaces the teeth? This is an important fact, which goes far to enlighten us upon the choice of means proper for replacement.'

"The importance of muscular influence in the production or correction of malocclusion was also recognized in publications by Gainé in 1856, Bridgman in 1859, and Coleman in 1865.

"Tomes, in 1873, ascribed virtually all irregularities of the jaws and teeth to alteration of the normal balance between the muscular forces.

'... Along the outside of the dental arch the muscular structures of the lips and cheeks are perpetually exercising pressure perfectly symmetrically, and on the inside the tongue is with equal persistency doing the same thing. Now if we imagine a plastic material placed between the tongue and the lips, it cannot fail to be moulded into the form of a regular dental arch, and this is precisely what happened with the mobile, freshly erupted teeth; ... There is, I believe, no such thing as a natural tendency towards the assumption of the regular form in a dental arch; the physical forces at work, namely, the lips and tongue, are amply sufficient to account for all the phenomena observed; and explanations based upon such a tendency fall, like references to 'vital force' as an explanation of physiologic phenomena into the category of mere forms of words calculated to cloak our real ignorance.'

²From "Anatomy of the Mouth," *Clinical Symposia*, 10:3:67-94, May-June, 1958, courtesy Dr. J. F. Huber.

“Edward Angle practiced and taught with acute awareness of these dynamic factors. In 1899, in *Dental Cosmos*, he wrote:

‘The harmonious relations of the occlusal planes and dental arches are further assisted by another force, namely, muscular pressure, the tongue acting upon the inside and the lips and cheeks upon the outside. The latter, so as to keep the arches from spreading, as do the hoops upon the staves of a cask; the former prevent too great encroachment upon the oral space. I am satisfied that this muscular pressure is a far more important factor in relation to the study and correction of malocclusion than is generally recognized.’

“In his classic textbook, *Treatment of Malocclusion of the Teeth*. Angle treated the subject in somewhat more detail:

‘The influence of the lips in modifying the form of the dental arches is an interesting study, and almost every case of malocclusion offers some noticeable and varying manifestation of it. In those cases where there is normal occlusion of the teeth it will be noticed that the lips and cheeks are also normal and perform their functions normally. The upper lip will be found to rest evenly in contact with the gums and upper incisors leaving, however, about one-fourth of the occlusal ends of the central incisors and laterals, and the points of the canines, to be covered by the edge of the lower lip, so that normally there is a restraining force exerted upon the upper incisors and canines by both upper and lower lips. This force is exerted automatically in response to almost every emotion, and results in maintaining the teeth in harmony with the graceful and beautiful curve of the normal individual arch.

‘In cases of malocclusion strikingly characteristic abnormalities in lip function are often noticeable, leading to the suspicion that more often than is recognized the peculiarities of lip function may have been the cause of forcing the teeth into malpositions they occupy . . .’

‘. . . Doubtless, also, peculiarities of disposition, and their manifestations in movements of the lips, in many instances so modify the force exerted upon the teeth as to influence the form of the dental arches.

‘Another striking instance of the lack of the requisite amount of force exerted by the lips and cheeks upon the external surfaces of the arch is presented in certain cases of patients suffering from cleft palate which involves the intermaxillary bones and upper lip. The lateral halves of the arch spread abnormally to a greater or less degree, in some instances the teeth of the upper jaw closing completely outside those of the lower.’

“Thus, it is seen, that from the very emergence of orthodontia as a discipline of the dental art and science, investigators and clinicians in this field have had a fine appreciation of the profound influences wielded over the jaws and teeth by the forces exerted by the oral and facial musculature.

“Naturally, the individual forces of occlusion cannot be considered in isolation, but rather must be recognized as an integrated dynamic complex, which under ‘normal’ conditions is maintained in a state of precise, though still dynamic, balance.

“This brief historical resumé of the appreciation by orthodontists of muscular elements as a potent force in the development and maintenance of occlusal relationships is included because it is this force, interacting with the congenitally deficient substrata, which produces the typical deformities seen in the dental arches of patients with cleft lip and cleft palate of the more severe types. Also, the principles involved are in no way new, but have been recognized for many decades.

FIGURE 14. Buttress forces in the normal and cleft palate. Courtesy of *The Angle Orthodontist*.

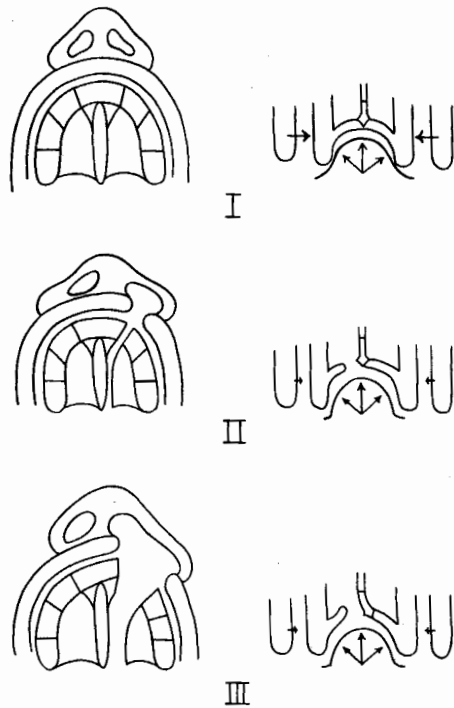

“For the purpose of this presentation a somewhat more detailed description of what we term ‘arch collapse’ in the cleft palate patient is in order. The normal maxillary alveolar arch (Figure 14), a suspended extension of the maxilla and premaxilla, gains considerable structural integrity from its classic arch configuration. In addition, it is stressed within by ‘flying buttresses’ formed on each side by the continuity of the palatal bones, vomer, and nasal septum, as seen in I. These ‘buttresses’ resist both compression and expansion of the arch. Internal stressing is further aided in resisting outside forces of compression (the muscles of the lips and cheeks) by action of the tongue beneath and within the arch. Unaltered by specific pathology or congenital malformation, these various components of force remain in balance and maintain a normal symmetrical arch which, with reasonably normal growth and eruption of the teeth, assumes a normal and functionally efficient relationship with the alveolar arch and teeth of the lower jaw.

“Now let us consider the infant with cleft lip and palate of Type III (cleft of entire soft and hard palate in continuity with unilateral cleft of the alveolus and usually complete cleft of the lip, as depicted in II). Prior to repair of the lip, the external forces of compression are absent or greatly reduced, and a ‘key stone’ of the arch is disengaged or perhaps partially absent, breaking the continuity of the arch. In addition, the ‘flying buttress’ has been removed

FIGURE 15. Medial displacement following lip repair. Courtesy of *The Angle Orthodontist*.

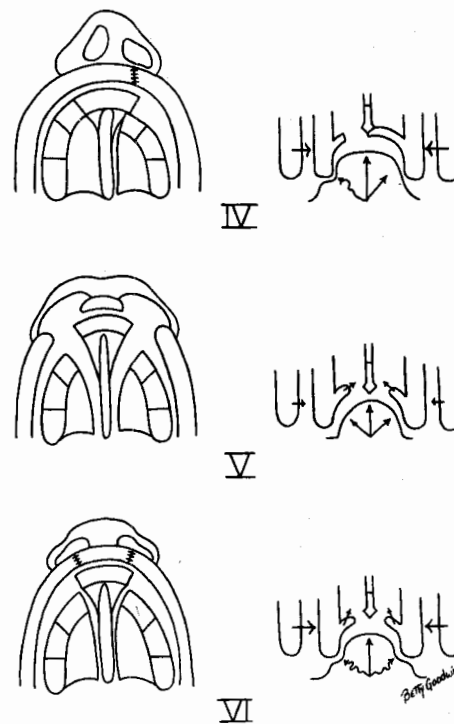

from the short (cleft) side. Meanwhile, beginning in utero, the tongue exerts an internal force of expansion. This force is virtually unopposed on the cleft side and is exerted against decreased antagonism on the non-cleft side. The result is a widening of the cleft with expansion of the arch, more marked on the cleft side, together with anterior rotation of the premaxilla, as depicted in III.

"Lip repair, which usually is carried out prior to four months of age and before ossification of the facial bones is complete, restores the labio-buccal sphincter with its compressive force. If the surgeon's skill and the tissue available for repair permit, this force will be restored to 'normal'. If either or both are deficient, it will be reflected as tightness of the lip and increased compressive force applied to the arch. In any event, the expanded arch promptly yields to this muscular pressure despite the continued effort of the tongue. The alveolar process on the cleft side drifts toward the midline and the anteriorly rotated premaxilla swings back toward its normal position. If these forced migrations occur at a complementary rate and the congenital tissue deficiency is not too great, the alveolar process of the cleft side and the premaxilla may reach the normal arch-line at the same time and impinge, restoring the structural integrity of the arch and preventing further significant medial displacement of the short segment. If this happens, the resulting arch contour is normal or nearly so, and the prognosis for normal maxillary development with a satisfactory dental occlusal relationship is good. Unfor-

tunately, such cases are rare. By far the more usual occurrence is for the alveolar segment on the cleft side to drift medially at a rate that exceeds the rate of posterior rotation of the premaxilla, possibly because the latter receives support from the vomer and the septum which must be overcome to effect rotation. Consequently, the short lateral segment passes the normal arch-line prior to the arrival of the premaxilla and, continuing to drift medially, becomes contained behind and within it (Figure 15, IV). In a significant number of cases there appears to be sufficient alveolar aplasia at the cleft site to preclude

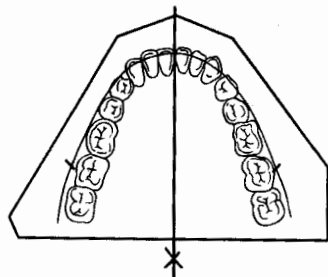

DETERMINATION OF THE MIDLINE
OF THE MANDIBULAR ARCH

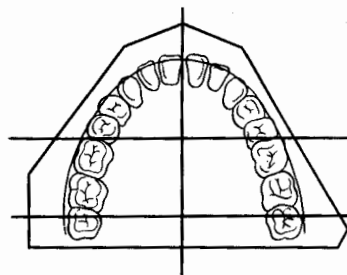

TRANSFERAL OF THE MANDIBULAR MIDLINE
TO THE MAXILLARY PHOTOGRAPH AND DIVISION
INTO QUADRANTS

FIGURE 16. Courtesy of *The Angle Orthodontist*.

impingement on the normal arch-line, irrespective of any coordination in the repositioning of the involved segments. In either event, the arch is narrowed according to the degree of medial displacement or 'collapse' of the alveolar segment on the cleft side.

"In clefts of Type IV (complete cleft of the soft and hard palate in continuity with bilateral clefts of the alveolus and lip) the same forces and defects exert their influence, the only difference being that both alveolar segments lose the support of the palatal bones and vomer, and the premaxilla is suspended from the anterior margin of the septum, free of any alveolar attachment. Prior to repair of the lip, expansion of the arch may be profound and the premaxilla may be displaced far anteriorly and rotated superiorly as

FIGURE 17. Courtesy of *The Angle Orthodontist*.

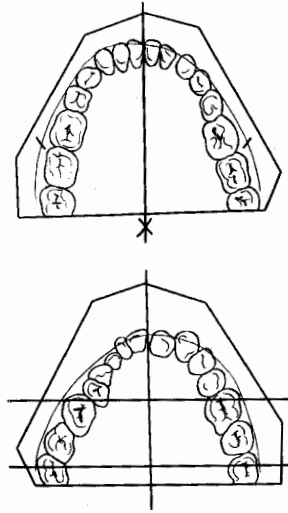

DIAGRAMMATIC SKETCH OF TYPE III CLEFT PALATE DEMONSTRATING ARCH COLLAPSE

seen in V. Lip repair can result in collapse of either side and not infrequently produces bilateral collapse, with the alveolar segments meeting on the midline behind the protruding premaxilla, 'locking it out' of the arch as depicted in VI."³

In order to find out just how important this problem was in our cases, we developed the following technique.

"Each dental study model was trimmed in centric occlusion with the base of each model-half parallel to the occlusal plane. Each model-half was then separately photographed at a fixed distance with the center of the occlusal plane directly in front of the point of focus. The photographs were printed on special paper⁴ to eliminate distortion in processing. The recommended processing and air drying produced consistently good prints on which the outlines of the alveolar processes and the dentition could be clearly seen.

"On the mandibular half of each photograph the buccal and labial borders of the alveolar processes were outlined. The interspace between the lower central incisors at the lingual gingival line superior to the genial tubercule (the most consistent 'mid-line' point identifiable in our experience) was used as a center and from it arcs were struck to cross the buccal outline of the mandibular alveolar process on each side. The paired crossing points were then used as centers to strike additional intersecting arcs. These arcs were of identical radius for each pair of cross-points and intersected at points within

³Courtesy of *The Angle Orthodontist*.

⁴Kodak Resisto Rapid.

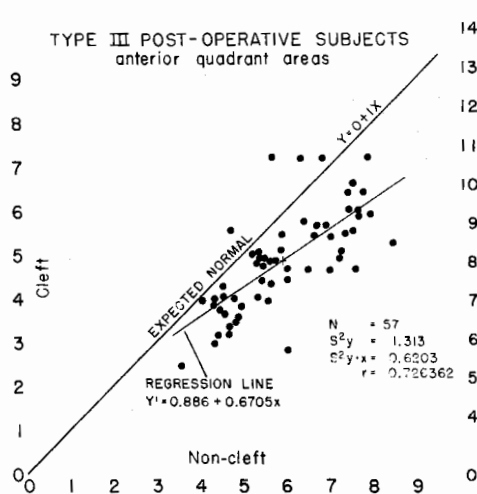

FIGURE 18. Courtesy of *The Angle Orthodontist*.

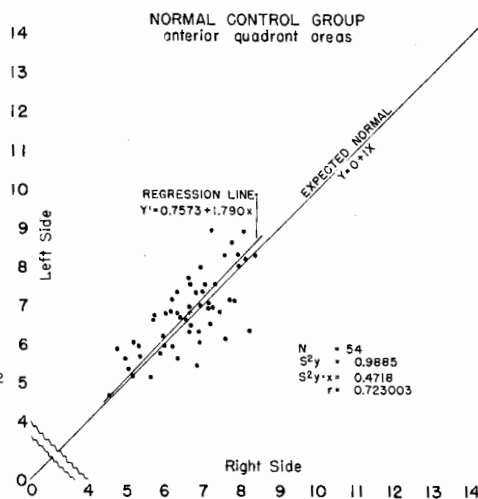

FIGURE 19. Courtesy of *The Angle Orthodontist*.

and equi-distant from the external borders of the mandibular arch. Thus a 'functional midline' on the occlusal plane was determined for the lower arch (Figure 16).

"The buccal and labial border of the maxillary alveolar arch was then outlined on the photograph of the upper model-half. By using a bright x-ray view-box and two or more corresponding points on each model-half for orientation (the models were trimmed in occlusion so corresponding corners of the model bases could be used for such orientation) the photographs could be put face to face and placed 'in occlusion'. The functional midline could then be transferred from the lower arch to the upper by pricking through a series of points with a sharp instrument. After the midline was transferred to the photograph of the upper arch, a posterior transverse line, perpendicular to the midline was drawn through the area of maximal arch-width in the molar region. A second parallel transverse line was drawn across the arch midway between this line and the anterior extent of the mid-line. Thus the upper arch was divided into four quadrants, one anterior and one posterior on each side of the derived midline transferred from the lower jaw (Figure 17). The area of each quadrant was then determined with the rolling disc planimeter. Each step was carried out by each of two separate investigators and the correlation of the two sets of data approached unity. The means of the two sets of data were used in the final analysis. Dental arch collapse as reflected by asymmetry of the anterior quadrants is depicted schematically in Figure 17.

"Scattergrams were made of the palatal area measurements of the sub-mucous, Type I, Type II, Type III, and Type IV post-operative clefts. No evidence of arch collapse was found in the Type I and Type II cleft groups.

"A scattergram of the anterior quadrant areas of the Type III post-operative

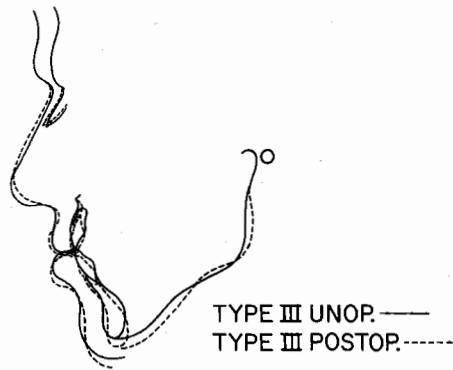

FIGURE 20. Comparison of bone growth between post-operative and unoperated cases of cleft palate. Courtesy of *Journal of Dental Research*.

group is seen in Figure 18. This showed a marked decrease of the anterior quadrant on the cleft side as compared with the noncleft. A similar scattergram of the control group of normals (Figure 19) revealed no such difference of areas on either side of the midline.

“Identical studies were carried out in regard to comparison of the areas of the posterior quadrants of the Type III post-operative cleft palate patients. The marked differences as seen in the anterior quadrant area measurements were not evident.

“The technique used in this study permits the introduction of certain subjective differences, for example, in tracing the outline of the gingiva or in establishing the midline of the maxillary arch from the mandibular arch. Nevertheless, after considering many alternatives, it turned out to be the most consistent and accurate means of measuring dental arch areas, and despite the opportunities for subjective differences two separate investigators arrived at almost identical results.

“It is evident from evaluation of the results that there is a significant decrease in palatal area of the anterior quadrants on the cleft sides as compared with the non-cleft in the Type III cases, indicating a significant and profound dental arch collapse in this area. Such a collapse was not seen on examination of the posterior arch quadrants in this type of cleft defect.”⁵

“It is well known that many people with a cleft extending through the palate, alveolar ridge, and lip have an abnormality of facial contour characterized by a depression or flattening of the mid-face. This has been ascribed by some to the injurious effect of palatal surgery on the growth of the maxilla. In our studies, no marked differences in bone growth were seen between the post-operative and unoperated cases of cleft palate (Figure 20). The abnormality of facial contour that was seen, therefore, cannot be ascribed to a lack of maxillary growth resulting from conventional soft-tissue palatal surgery.

“On the other hand, lingual version of the incisor teeth, both maxillary and mandibular, was a significant finding in the post-operative cases of cleft palate

⁵Courtesy of *The Angle Orthodontist*.

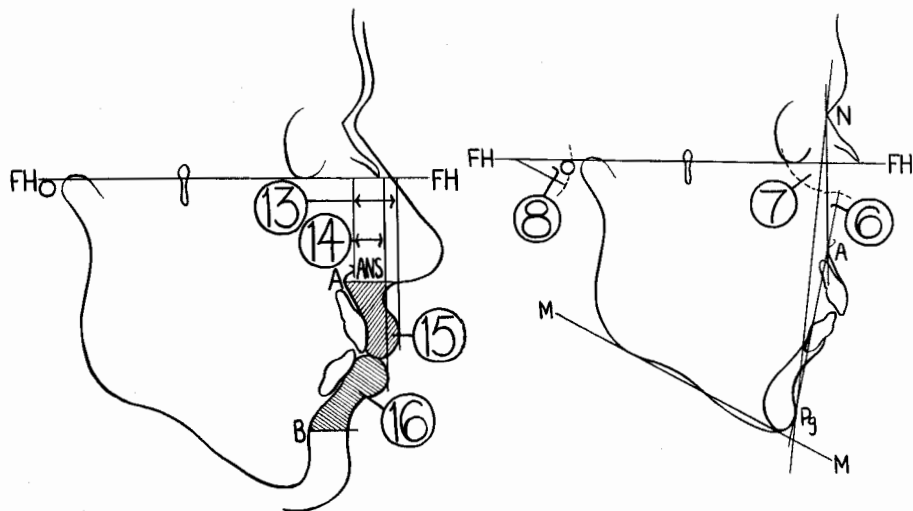

FIGURE 21. Diagram showing derivation of linear and cross-sectional measurements of lips. (Courtesy of *Journal of Dental Research*.)

FIGURE 22. Diagram showing derivation of linear and angular measurements (Courtesy of *Journal of Dental Research*.)

but not in the unoperated cases. It is difficult to see how palatal surgery could be responsible for this result. If one considers the age at which the lips were repaired, however, an important factor comes to light. In the unoperated cases of cleft palate, the cleft lips were closed at a mean age of about 24 months. Apparently the same factors that were in force to prevent palatal surgery affected a delay in lip repair in these cases. As a result of this delay, the infants were appreciably larger, with a resultant simplification of the lip surgery for the surgeon. Perhaps other factors, such as the maturity of the dentition and the extent of the calcification of the maxilla at the time of lip surgery, also play a role in the eventual facial contour.

"In our study the post-operative cases of cleft palate had lip repair carried out at a mean age of three months. To effect a loose, full lip in small infants of this age requires considerable surgical skill, coupled with a sound plan of plastic repair. Small technical errors, with failure to utilize all possible tissue, can lead to gross irregularities and a tight lip in ensuing years.

"If it is true that the lingual version of the incisor teeth in these cases is a result of a tight post-operative cleft lip, then one would expect to see a protuberant lower lip. It appears to be a general finding in cases of this type that the tighter the upper lip, the more protuberant and redundant the lower lip. As an indication of this, one can shorten his upper lip between his fingers and thereby produce an abnormal fullness and projection of the lower lip. Corrective surgery of a tight upper lip, by rotating a flap from the redundant lower lip (the Abbe-Estlander procedure) is frequently used to correct this anatomical phenomenon (Figure 21). The decreased anterior projection of the upper lip in the post-operative group most probably represents the lack of

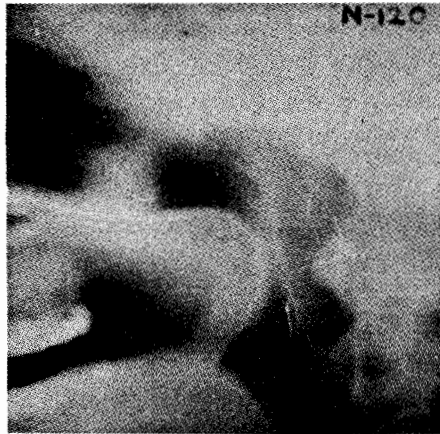

FIGURE 24. Laminagraph showing subject phonating [a]. Note how velum has moved posterosuperiorly. (Courtesy of *Journal of Speech and Hearing Research*.)

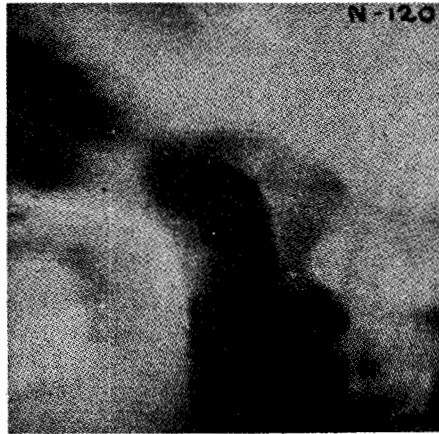

FIGURE 23. Laminagraph showing subject at rest position. (Courtesy of *Journal of Speech and Hearing Research*.)

support provided by the lingually displaced maxillary incisor teeth, since the cross-sectional area of the lip is not reduced. An increased cross-sectional area of the lower lip is found in this group of cases only and gives further substance

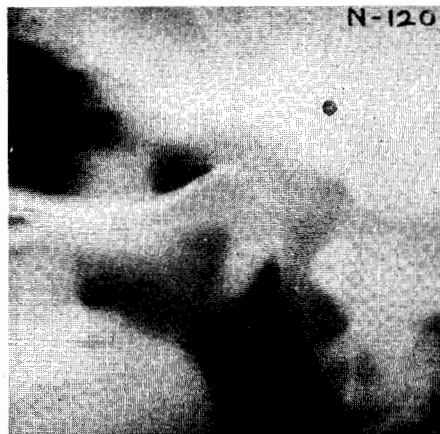

FIGURE 25. Laminagraph of subject saying [s]. Velopharyngeal contact is complete over a range greater than two centimeters. (Courtesy of *Journal of Speech and Hearing Research*.)

to the argument that a tight upper lip contributes significantly to this deformity. The possibility that a tight upper lip may play a role in limiting anteroposterior growth of the maxilla must also be kept in mind, especially in view of the fact that in a recent study, 18 Type III cases, almost entirely unoperated in regard to both lip and palate, were found to have no abnormalities of the angle of convexity or the facial angle (Figure 22)."⁸

⁸Courtesy of *Journal of Dental Research*.

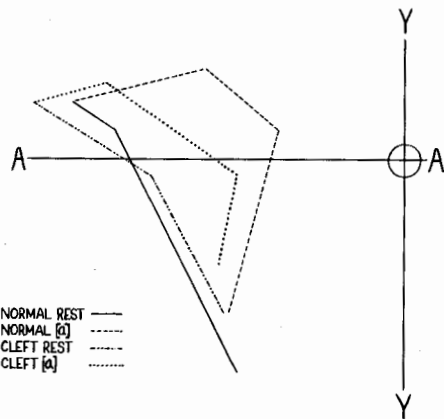

FIGURE 26. Diagram showing mean group profiles of posterosuperior surfaces of normal and postoperative cleft palates at rest and phonating [a]. Difference between rest and [a] contours represents amount of movement. (Courtesy of *Journal of Speech and Hearing Research*.)

FIGURE 27. Diagram showing mean group profiles of posterosuperior surfaces of normal and postoperative cleft palates at rest and producing [s]. Difference between rest and [s] contours represents amount of movement. (Courtesy of *Journal of Speech and Hearing Research*.)

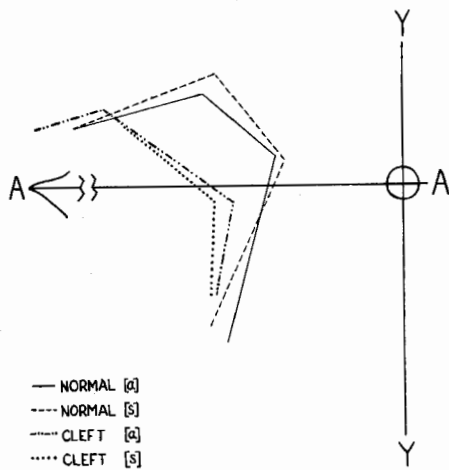
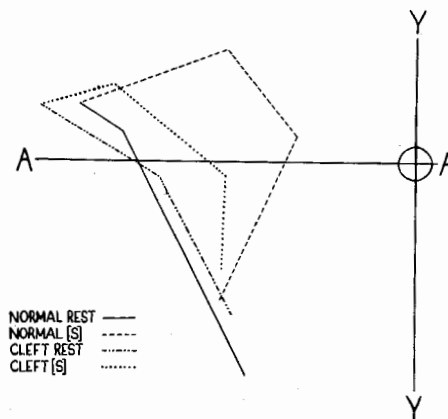

FIGURE 28. Diagram showing mean group profiles of posterosuperior surfaces of normal and postoperative cleft palates phonating [a] and producing [s]. From the [a] position the normal palates move toward the pharyngeal wall while the postoperative palates move away from it. (Courtesy of *Journal of Speech and Hearing Research*.)

Before we close we must take a brief look at the anatomical movement of the post-operative cleft palate.

"Palatal and pharyngeal movements in two matched groups, 50 subjects with normal palates and 50 subjects with post-operative cleft palates, were studied and compared by measurements of tracings from laminagrams of the palato-pharyngeal area made while subjects were at rest, phonating [a] and producing [s] (Figures 23, 24, and 25).

"The results indicate a tendency for more forward movement of the pharyngeal wall in the post-operative cleft group than in the normal group. A distinct limitation of activity was noted in the post-operative palates in all important functions: upward movement from rest to [a] was less than two-thirds that of normals (Figure 26), and from rest to [s] about one-third (Figure 27). Contact with the posterior pharyngeal wall during production of [s] was seen in all of the 50 normals but in only 17 of the 50 post-operative subjects. Posterior movement of the post-operative cleft palates was one-half that of normals for [a] and only one-third that of normals for [s]."⁷ (Figure 28)

SUMMARY

In conclusion, as we come to understand more fully, the many interrelated factors playing a part in the growth and development of these clefts, the more can be accomplished in restoring them to normality of function and appearance. A revolution in therapeutic concepts has now been brewing for about 10 years, and bids fair to change many of our previous practices. I am sure you will hear about this in detail in the excellent papers which follow.

This investigation was supported by a research grant (DE-00197) from the National Institute for Dental Research of the National Institutes of Health, Public Health Service.

REFERENCES

- ANGLE, E. H., Classification of malocclusion. *Dental Cosmos*, 41, 248-264, 350-357 (1899).
ANGLE, E. H., *Treatment of Malocclusion of the Teeth*. (7th Edit.), Philadelphia: White Dental Manufacturing Co. (1907).
BRIDGMAN, W. J., Lateral pressure. *Transactions of the Odontological Society of London*, 160-176, (1859-60).
COLEMAN, A., On some forms of irregularity of the teeth and their treatment. *Transactions of the Odontological Society of Great Britain*, 227 (1865).
DESIRABODE, M. A., *Complete Elements of the Science and Art of the Dentist*. Paris: 1843, translated by Crowley in *Amer. J. and Library of Dental Science*, Series 1, Vol. 7 (1847).
GAINÉ, C., *On Certain Irregularities of the Teeth With Cases Illustrative of a Novel Method of Successful Treatment*. Bath, England: (1856).
HAGERTY, R. F., and HILL, M. J., Pharyngeal wall and palatal movement in postoperative cleft palates and normal palates, *J. Speech Hearing Res.*, 3, 1, 59-66 (1960).
HAGERTY, R. F., Facial growth and dentition in the unoperated cleft palate. *J. Dental Research*, 42, 412-421, Jan.-Feb. (1963).
HAGERTY, R. F., and others, Dental arch collapse in the cleft palate patient. *The Angle Orthodontist*, in press.

⁷Courtesy of *Journal of Speech and Hearing Research*.

- HUBER, J. F., Anatomy of the mouth, *Clinical Symposia*, 10.3, 67-94, May-June, 1958
- LEFOULON, P. J., *A New Treatise on the Theory and Practice of Dental Surgery*. Paris: 1841. Translated by Bond in *Amer. J. and Library of Dental Science*, Series 1, Vol. 5 (1844).
- ORBAN, B. J., *Oral Histology and Embryology*. (4th Edit.), St. Louis: The C. V. Mosby Co. (1957).
- RODRIGUES, B. A., Memoranda from Notebook (Correction of Malocclusion) *Amer. J. of Dental Science*, Series 1, Vol. 1 1839-41.
- SWOISKIN, B. L., Lower arch form in unilateral cleft palate. *The Angle Orthodontist*, 27, 3, 124-132 (1957).
- TOMES, C. S., The bearing of the development of the jaws on irregularities. *British J. of Dental Science*, 26, 367-370, 1873.

UPPER RESPIRATORY ACTIONS OF THE INFANT

JAMES F. BOSMA

National Institute of Dental Research, Bethesda, Maryland

H. M. TRUBY

IBM Laboratories, San Jose, California

JOHN LIND

Karolinska Children's Hospital, Stockholm, Sweden

Quiet respiration of the normal young infant is typically through his nose. His mouth is closed by active apposition of this tongue to hard palate and adjacent soft palate and, less consistently, by apposition of upper and lower lips and the tongue (Bosma and Lind, 1962).

The pharynx and larynx are active in performance with each respiration, expanding about the air stream with inspiration and contracting with expiration. The varied actions of respiration, such as grunt, cough, and cry, are principally differentiated in the pharynx and larynx. It is here that respiration interacts with posture and struggling actions of the neck and trunk. And here, also, respiration interacts with feeding.

These various respiratory actions and interactions of the pharynx and larynx are more clearly distinguished in the newborn infant by reason of his neurological immaturity and his anatomically different proportions and spatial arrangements in this area (Figure 1). The pharyngeal respiratory chamber varies more in volume during phasic respiration than does that of the mature subject. These motions are more diffuse, so that the mesopharynx more often supplements the expiratory valving actions of the larynx. This motor diffuseness is also shown in different interactions of posture or struggling efforts with respiration, for each of these activations overflows to effect constriction of the pharynx. In quiet respiration the volume variations of the pharynx are slight, but the pharynx and the laryngeal vestibule continue to be patent. This patency of the pharyngeal airway is a distinguishable physiological mechanism. It is apparently cued from the respiratory stream, for the pharynx is commonly closed in the tracheotomized infant.

This mechanism of airway patency must mature in motor function. With

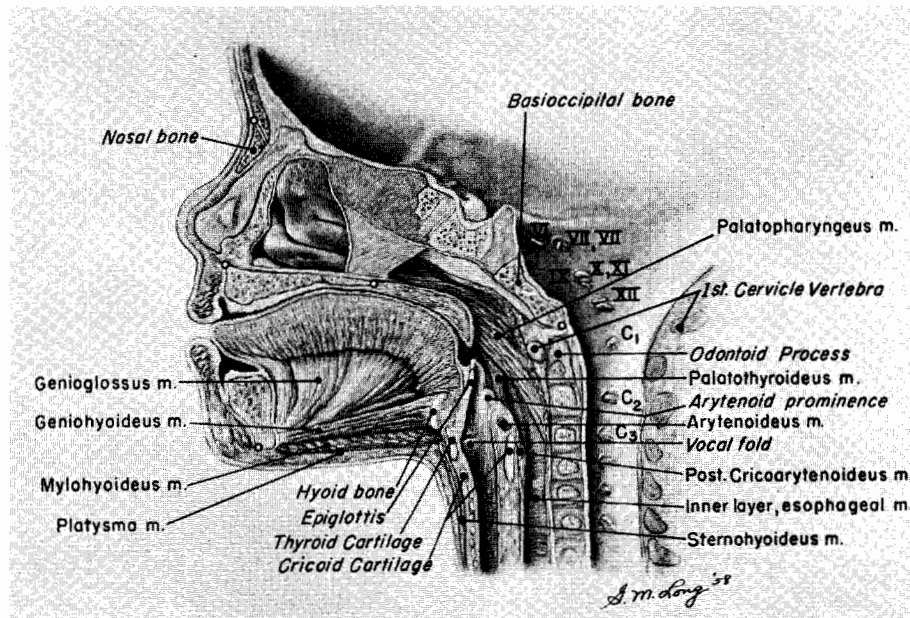

FIGURE 1. Dissection illustrating the musculature of the oral and pharyngeal region in the term newborn infant. Saggittal view of pharynx and mouth. Mucosa of the pharynx is removed and the larynx and trachea are displaced ventrad to show the intrinsic pharyngeal muscles. The cephalometric points of nasion, basion, anterior and posterior nasal spine, and menton are indicated by white dots.

greater positional stability of the cervical area generally, the pharynx walls are also stabilized. This motor maturation is of particular significance as the pharyngeal region enlarges differentially in human postnatal development. The highest level of its achievement is that of the stability of pharyngeal walls in mature speech, against which background of stability the finely discriminate motions of articulation may be accomplished.

This positional mechanism of the pharyngeal airway is accomplished by the supporting musculature of the pharynx, larynx, hyoid bone and tongue, which adapt the pharyngeal contour and diameters to variations in head, neck and mandible position. Actually, of course, these supporting muscles of the pharyngeal area are integrated in their function with the whole complex arrangement of the musculature about the cervical spine and about the mandible. And it is suggested that this positional mechanism about the pharynx may be the developmental prologue of cervical posture.

The young infant's arousal response to pain stimulation is expressed particularly in his respiratory motor system.¹ The alternations of expiration and inspiration are adapted particularly by exaggerations of expiration. And these

¹Bosma, J. F., Truby, H. M., Lind, J. Cry Motions of the Newborn Infants: Acta Paed. Scan. publ. pending.

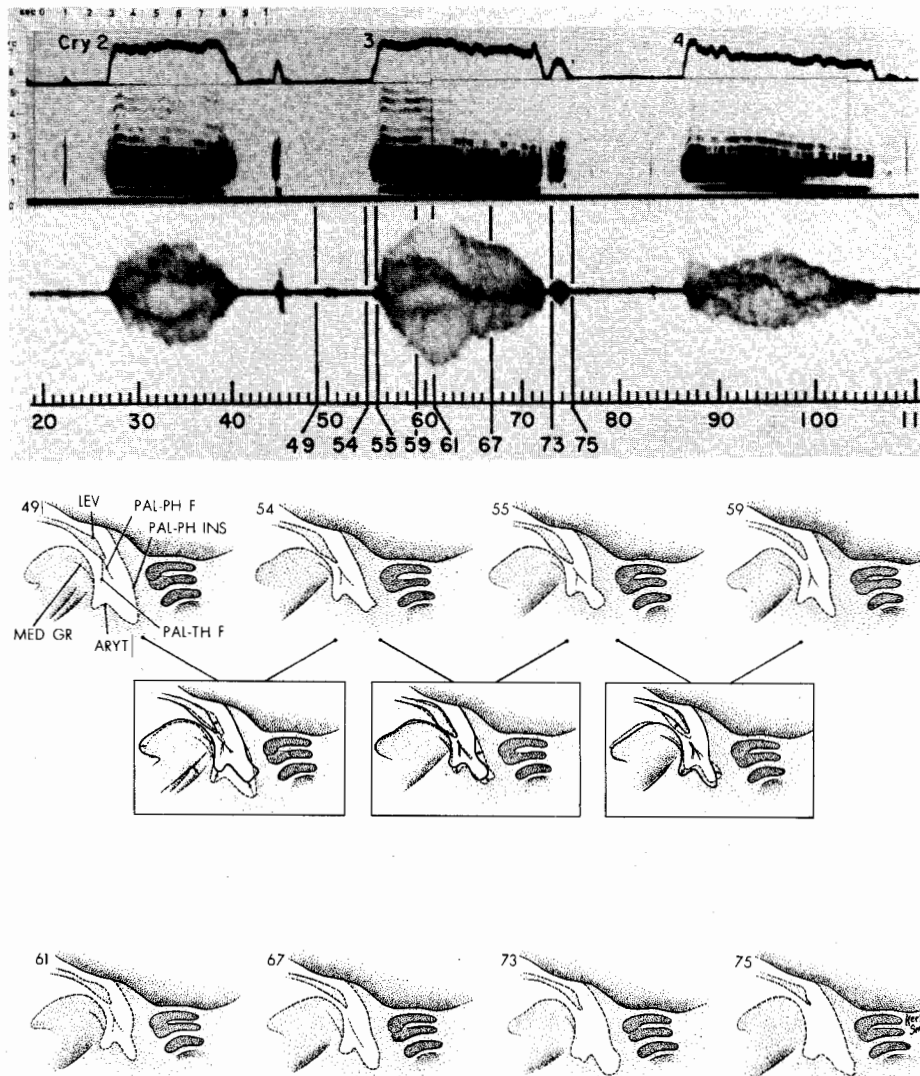

FIGURE 2. Acoustical patterns and cinefluorographic frames and tracings illustrating pharynx motions during a cry of moderate intensity. Infant, natal weight 3070, on third postnatal day, Acoustical record is of sound volume (upper line), sonographic display of frequencies to 5000 cps, and gross phonogram. The lowest line is the cinecamera frame marker. The gross phonogram and frame marker are ink-on-paper recordings which are photographically size-matched to the sonagrams and aligned to the sonagrams visually. The frames 49, 54 and others, which are illustrated in B, are indicated by vertical lines.

These cries are comparatively stable in harmonic composition, without the phenomena of tonal shift and imposition of turbulence which are found in other cries during this arousal, and in a later arousal which is illustrated in Figure 2. The cry vocalization extends in phonatory pattern into the succeeding inspiration in cries 2 and 3.

Cinefluorographic frame prints and tracings are selected to demonstrate displacements in the pharyngeal area during cry 3. Pharynx delineations are facilitated by barium suspen-

sion instilled nasally and by placing the pharynx region centrally within radiographic field. The infant's head is held manually and trunk is held manually and by swaddling. Little head and neck motion occurs during this cry.

The motions of the pharynx are representative of those in cry, with progressive constriction and elevation in frames 49-61, and reciprocal opening in frames 61-75. The displacements during accumulation of the cry effort are further demonstrated by the overlay tracings of frames 49 and 54 and 55, 55 and 59. These show that the lower portion of the wall, into which the palatopharyngeal folds insert, momentarily leads the rest of this pharynx margin in its ventrad displacement. This is at the onset of audible cry, frame 55. The pharynx is also slightly shortened in its cephalo-caudal axis by upward displacement of the arytenoid mass and the pharyngo-esophageal junction. These displacements, in turn, affect those of the larynx and hyoid accomplished by the extrinsic muscles which suspend the lower part of the pharynx from the cranium, mandible, and sternum. Simultaneously, the soft palate changes to a contour appropriate to traction of the levator veli palatini muscle. The palate is displaced slightly toward the skeletal roof of the epipharynx and also dorsally, in direction appropriate to combined traction of the levator and the palatopharyngeus muscles.

The displacements of pharynx in frames 61-75 are of progressive opening. The protrusion of dorsal wall, at the site of *palatopharyngeus* insertion, is evened out as the pharynx wall moves dorsally and caudally. The laryngeal vestibule, anterior to the arytenoids, is opened by the descent of the larynx and ventrad displacement of the tongue. The levator prominence upon the soft palate, frames 73 and 75, is a variation from palate contour in other inspirations and is apparently associated with the extension of vocalization into the succeeding inspiration.

exaggerations pace a more general surging of activity wherever this may be manifested in the greater tensing and the struggle movements of neck and trunk, of mouth, and of arms and hands.

The pharyngeal, laryngeal and thoracic adaptations of respiration during crying and the associated struggles (Figure 2) are well shown by the combination of cimeradiography, acoustic recording, and recording of air pressure and displacement phenomena. The adaptations of the pharynx and larynx are different in general schedule, in pattern, and in quality or degree of discrimination. The pharynx expands in inspiration and diminishes in expiration. The degree and directions of these motions are correlated with the current stage of the infant's motor development. The laryngeal motions are more abrupt and accomplish sustained tonal vocalization.

These actions of the larynx and pharynx essentially define the infant's cry, for the trunk motions of respiration follow these upper respiratory actions. The mouth is held open in tensed position, except for those motions of the tongue which are part of pharyngeal participation in cry.

The general pattern of an infant's arousal response is that of exaggerated, surging expiration. These surges are signalled by his cries and demonstrated also by tensing of the neck and trunk, opening of mouth, and flexion of limbs. Essentially the infant's whole motor expression is gathered about his succession of cries. The laryngeal coordinations, observed by accomplished sounds, are the most discriminate expression of this activity. The expiratory constrictions and inspiratory expansions of the pharynx and the trunk are grosser expressions. And the motions of structures more peripheral to the respiratory system are grosser still. In strong response, particularly of more labile infants,

the cyclic surging motions of stem, mouth, limbs, and fists freeze into sustained contraction.

The pharyngeal adaptations in the cry expiration consist essentially of an exaggeration of the expiratory constriction and of soft palate motions which are reciprocal in direction from those of mandible and tongue, so that the airway is deflected from nose into mouth. The dorsal pharyngeal wall moves ventrally toward the constrictor muscle origins on the pterygoid part of the facial skeleton, and on the hyoid and the larynx.

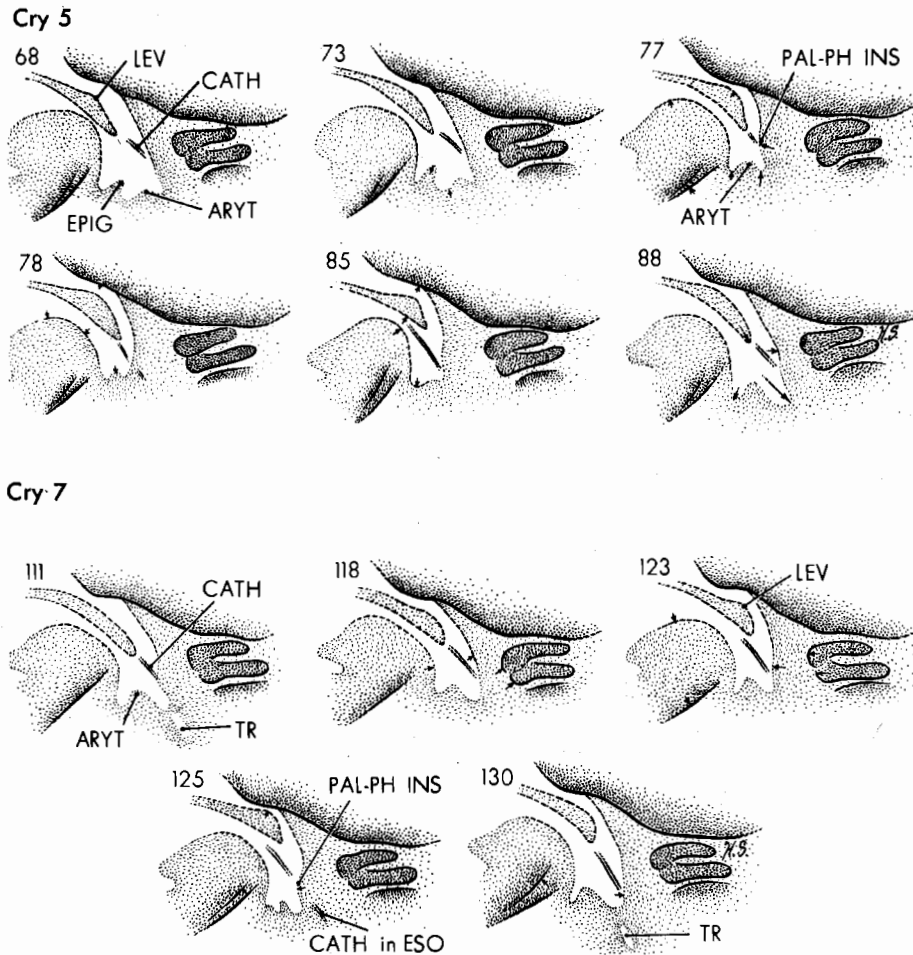
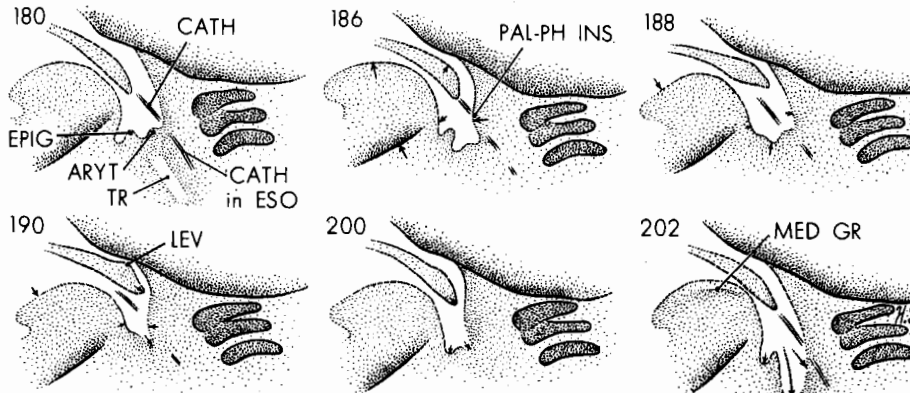

FIGURE 3. Series of cries showing variations with degree of effort and in association with struggle. Acoustical patterns, intra-thoracic pressure recording and cineradiographic frame tracings from a second series of cries of same infant as Figure 2. The upper recording line is sound volume. The third line, below the sonagrams, is intra-esophageal pressure. The pressure variations and the frame markings were photographically size-matched to the sonagrams and aligned to them visually for this illustration.

Simultaneously, the soft palate and palatopharyngeal folds are drawn toward the pharyngeal walls and, thus, constrict the palatopharyngeal isthmus and deflect the expiratory stream and the phonatory column of cry into the mouth. As part of this general action, the tongue becomes grooved in midline with cry expiration (Figure 3) apparently reflecting competition of *genioglossus* midline traction toward symphysis portion of mandible with the *styloglossus* traction of the lateral portions of tongue body laterally and

Cry 10



Cry 13

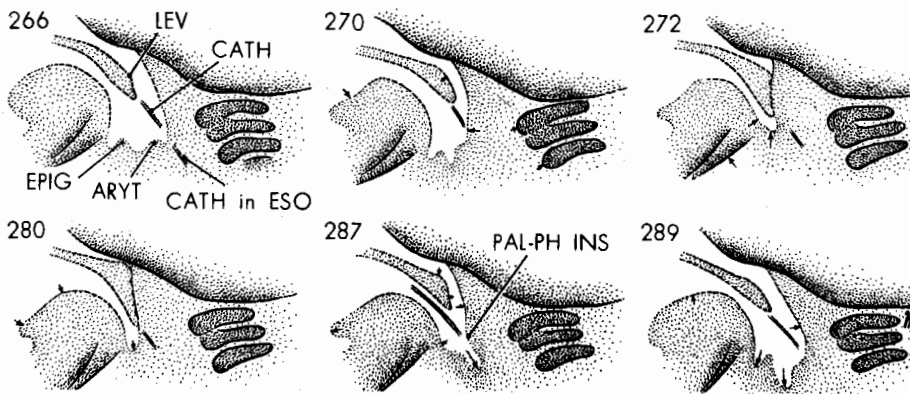

The cries 6, 7, 8, and 9, of moderate intensity, demonstrate stable harmonic patterns, similar to those of Figure 2. During greater intensities of cry effort we see both abrupt frequency increment, or "shift," and the imposition of turbulence. Thus, the sounds of cry 5 are initially similar to those of cry 7, then at approximately its midpoint (frame 83) its frequencies are shifted abruptly into higher range. Similar patterns of shift, characteristic of this infant, as well shown in cries 15, 16, and 17. Cry 5 also differs from cry 7 in the

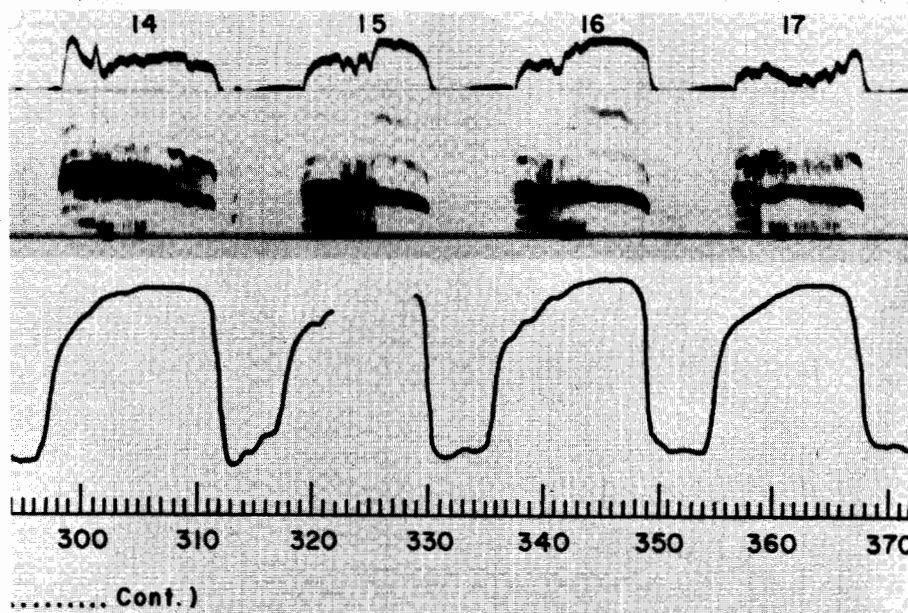
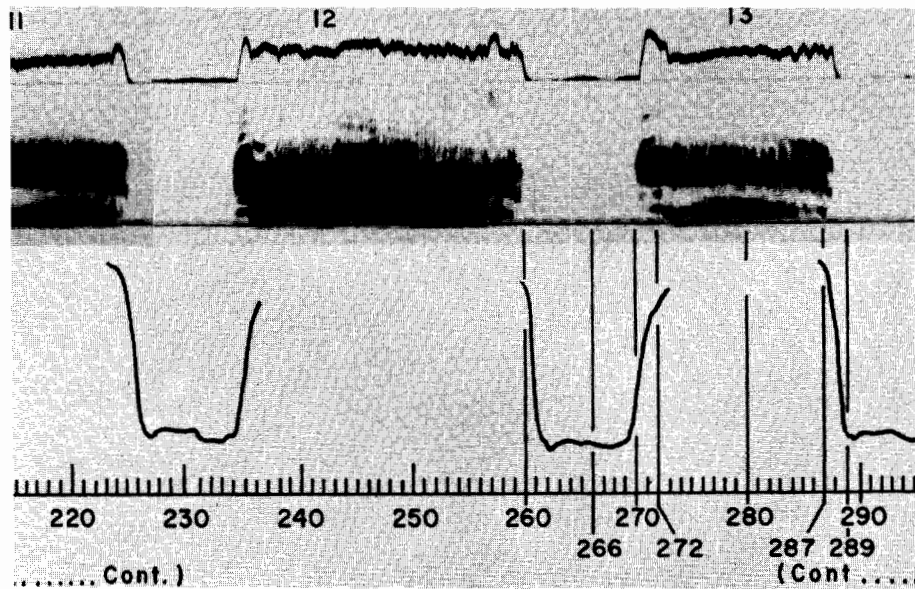

imposition of turbulence, which is manifested as an indistinctness of the harmonic patterns in mid-cry, obscuring both the basic harmonic tones and shifted displacement. Turbulence is seen in greater degree in cries 14, 15, and 16. It is more conspicuous in cries 10, 11, and 13, essentially obscuring the shift phenomena, as demonstrated by this sound spectrographic method. In cry 12, unpatterned turbulence dominates the whole of the spectrogram, except the initiation of the cry. Turbulence is also found in this infant's occasional extensions of cry vocalization into the next succeeding inspiration.

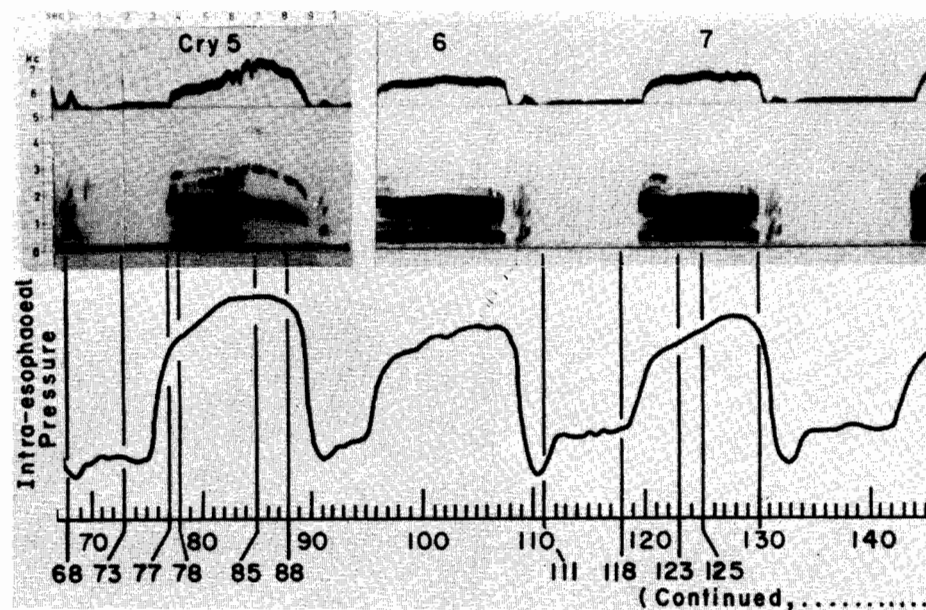
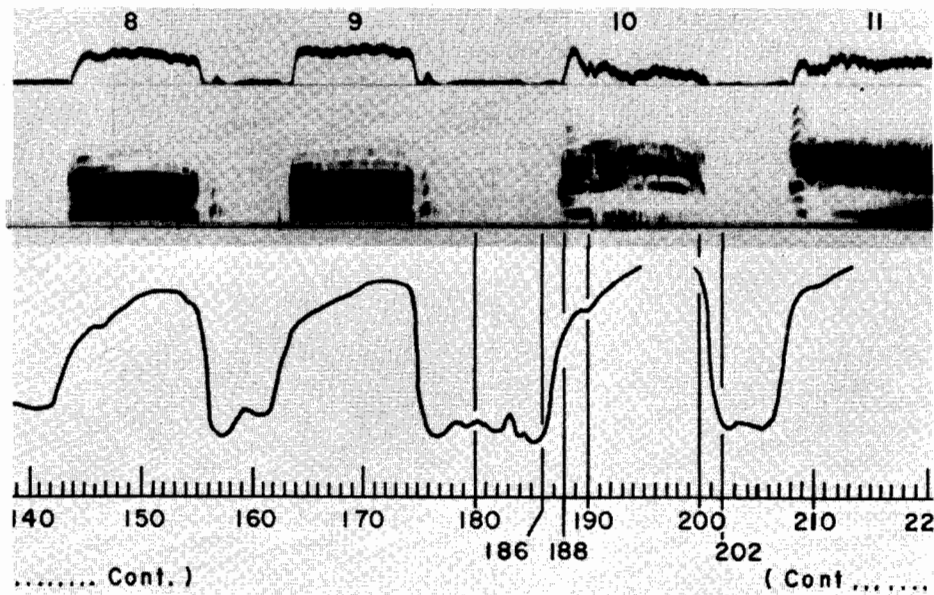

The increase of pressure within the esophagus, reflecting that within the thorax generally, is moderate in cries 6, 7, and 9, more in cry 5, and most in cries 12 and 13, though their higher pressures in these latter cries are not fully indicated, due to technical limitations of the recording.

The cinefluorographically demonstrated pharyngeal motions vary correspondingly in the cries of differing degree of effort. In cry 7, which is the least effortful of these four exam-

ples, the dorsal pharynx wall moves ventrad and returns dorsad in a graduation of displacements which is slow, compared with the abrupt onset and termination of the cry sounds. Definition of this pharyngeal wall motion is less clear in this example, by reason of cervical vertebral motions (indicated by arrows) as part of attempted flexion and extension of head and neck, while head is manually stabilized. The pharynx shortens slightly. The soft palate assumes a contour appropriate to levator traction, and it rises toward the skeletal roof of the epipharynx (frame 125). In coincidence with this elevation, the dorsal pharyngeal wall is displaced forward at the *palatopharyngeus* insertion upon the pharynx wall.

In cry 5 these pharyngeal motions are in similar pattern with a greater degree of cephalocaudal shortening. In cry 10, which is still more strenuous than cry 5, the shortening and constriction are greater. In cry 13, which is the most strenuous of this series, ventrad displacement of the dorsal pharyngeal wall is the greatest, and probably close to its maximum, for the palate and pharynx wall are in tight approximation, and the pharynx volume, below the palate, is minimal. In these more strenuous cries, 5, 10, and 13, the head and neck are stable, but the mandible descends farther with the cry than in cry 7.

dorsally. This median groove is greater in degree in less mature newborns. It is inconstantly demonstrated cineradiographically in its less degree in more mature newborns, depending upon its delineation by air or radiopaque media. The mandible is stabilized or may be drawn downward, away from maxilla. The oral cavity is opened.

The coordinations in cry expiration afford useful criteria of motor maturation in this area. The motor patterns indicate current development, even though these are but single nonsequential observations of infants at different stages of neurological development. Less mature infants demonstrate less positional stability of junction of head and neck, cervical vertebrae, and hyoid and larynx in relation to facial skeleton and cranium. (Compare Figures 3 and 5.) In the immature infant (Figure 5), the pharyngeal wall is more mobile, particularly in its lower portion. The dorsal wall of mesopharynx and hypopharynx moves far ventrad during cry expiration and far dorsad during inspiration. During cry, the soft palate and palatopharyngeal folds are displaced dorsally and elevated. This elevation is limited, for the *levator veli palatini* muscles of the newborn originate lateral to the pharynx at approximately the level of the dorsal margin of the hard palate; thus their action is more of dorsal displacement and tensing than as levators.

In more mature newborns, the constrictor portion of the lower pharynx moves less. This relative stability is coincident with the increasing positional stability of hyoid and larynx, associated with postural maturation of the anterior cervical area generally. As the upper pharynx enlarges and the constrictor portions of pharyngeal wall become more stable, the soft palate has greater spatial range available. Appropriately, it is in the cry of the more mature infants that we see the body of palate in transverse alignment (Figure 2). It may demonstrate a foot-like contour comparable to that seen in phonation of adults (Figures 2, 5). In more mature infants, with greater stability of the hyoid and larynx, the tongue motions are also discernably more stable with less of the immature rolling displacements, dorsally and caudally, pivoting upon the hyoid.

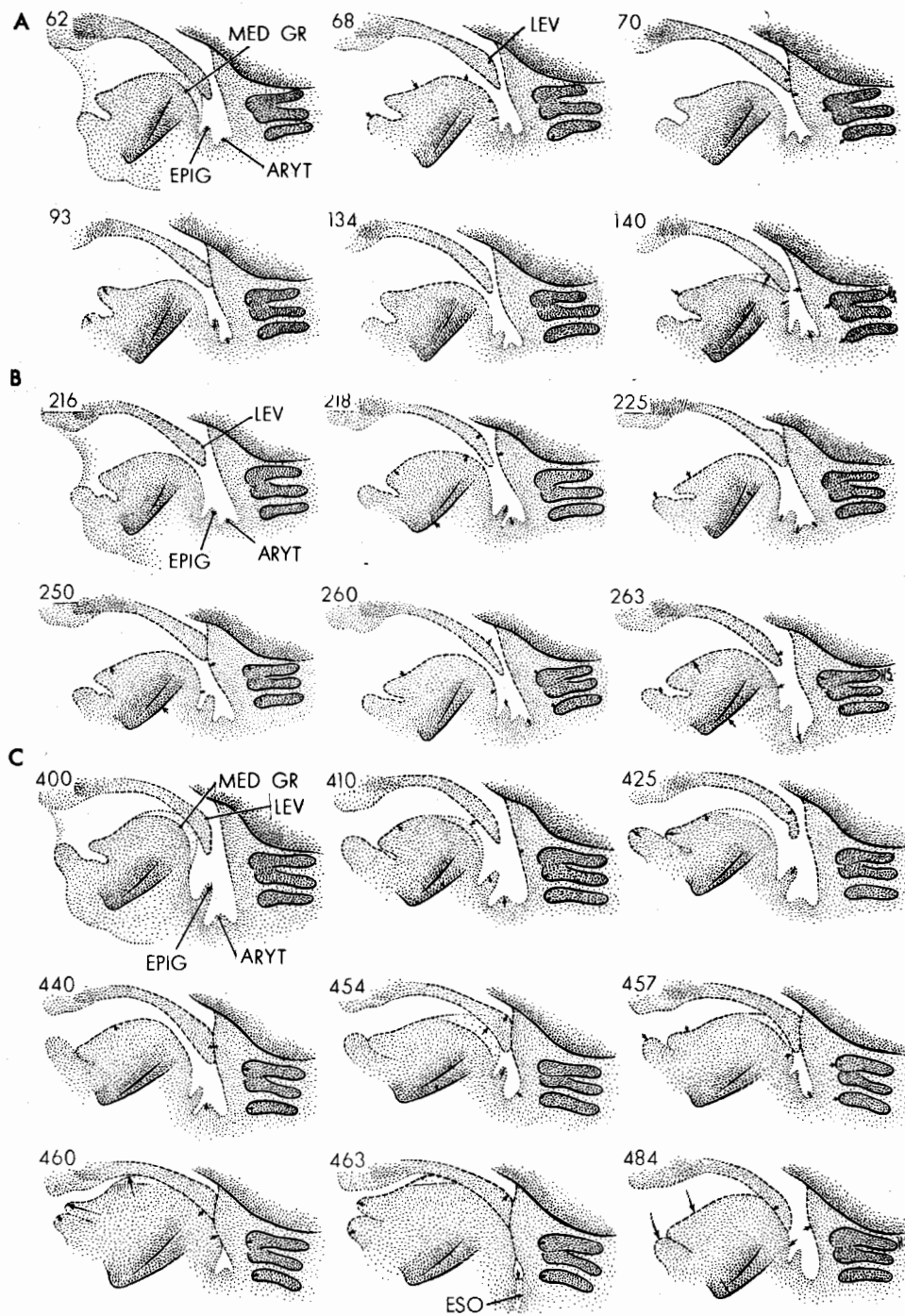

FIGURE 4. Motions of cry and of swallow. Infant of natal weight 3350 observed on fourth postnatal day, film 848.

This is a mature newborn. In comparison with infant illustrated in Figure 5, he shows less range of motion in the lower pharynx and greater motion in the upper pharynx. In the example 4A, of cry of moderate effort, the dorsal wall of lower pharynx, the arytenoid masses, epiglottis and dorsal part of tongue are notably stable in relation to each other and to the vertebrae and the mandible. The palate separates from the tongue and changes into contour indicative of levator traction (frame 68). Closure of the palatopharyngeal isthmus (frame 70) results from combination of further displacement of the palate and convergence of the adjacent pharyngeal wall.

In Figure 4B, of a briefer and less effortful cry, we note this same sequence of separation of soft palate from the tongue and its approximation to the converging upper pharynx wall.

Figure 4C is of swallow of barium bolus into esophagus, occurring ten seconds after the cry of 4B. This demonstrates similarity of dorsal pharynx wall motions in the initiation of swallow (frames 400-440) to those occurring in cry. In each, the palatopharyngeal isthmus is closed by a similar sequence of motions. In swallow, this closure becomes more extensive, as a part of the general constriction action.

As observed by this combination of methods the cry performance is found to be a combination of separable actions within the upper respiratory area. The progressive constrictions and dilatations of the pharynx are large in range and associated with gross alternations of tidal respiration and with a general exaggeration of other actions of the infant during the expiration. The constrictive actions at the larynx, indicated by acoustical observations, extend throughout the expiratory phase. At times, these actions may arrest expiration in sustained closure and, at times, extend into the succeeding inspiration.

The phonatory expressions are the most finely organized and most consistently patterned of all of the infant's motor coordinations. They also afford the most discriminate indications of the infant's current response state. These phonations are accomplished in the arytenoid apparatus of the larynx, with little apparent modulation by the pharynx and mouth (*vide infra*). The acoustical methods portray well their temporal organization and the discriminations within their pattern.²

However, we lack demonstration of the displacements of the arytenoid cartilages, vocal cords, the thyroid and cricoid cartilages, and the other folds and protrusions of the larynx which may contribute to the phonation variety discerned by a microphone applied at the neck. As in mature humans, these varied phonatory phenomena are accomplished by valvular constrictions; but the particulars of direction and schedule of displacement of the laryngeal elements are only grossly inferred at this time.

In arousal, the entity of cry is imposed upon respiration and, with greater distress, other valvular mechanisms are imposed in turn upon the cry coordination. Thus, a successive arrangement of impositions and superimpositions adapts these motor performances in similar direction of exaggeration of the constrictions of expiration.

²Truby, H. M., and Lind, J., Cry Sounds of the Newborn Infant: Acta. Paed. Scan. publ. pending.

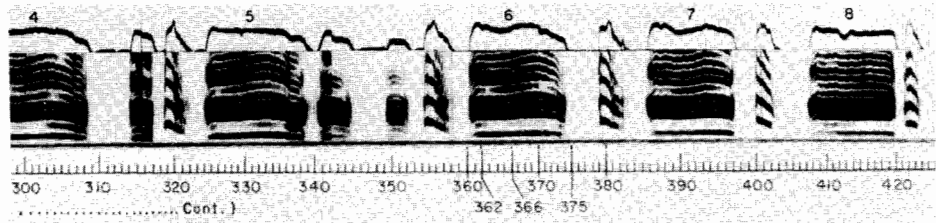
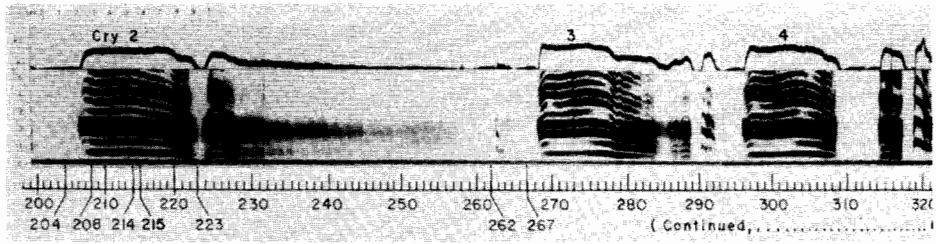

Cry 2

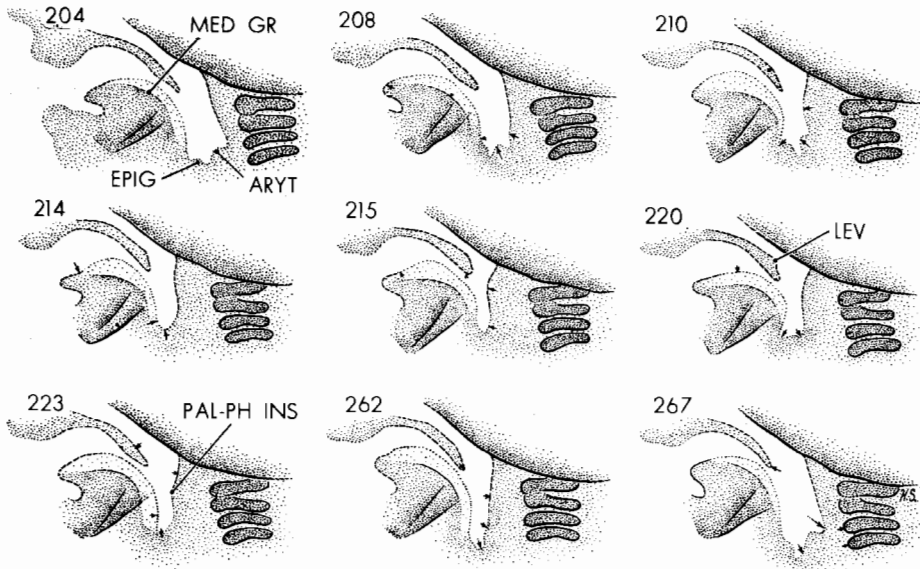

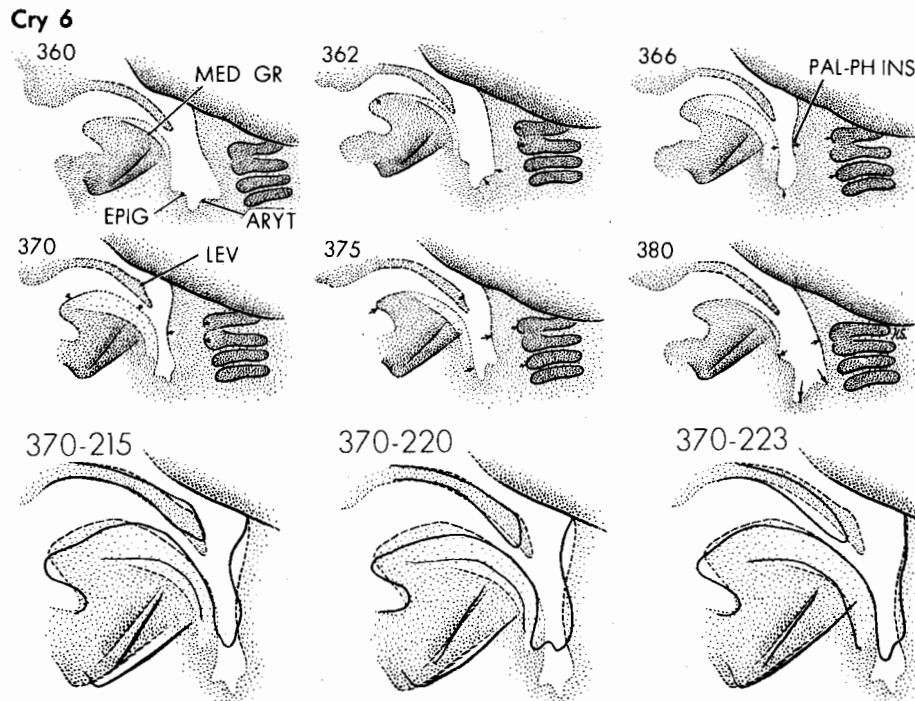

FIGURE 5. Sounds and motions of cry of a vigorous premature infant, natal weight 1930, on thirteenth postnatal day, film 798.

The laryngeal vocal coordinations are mature in their achievement of stable phonetic pattern and also in their repetitions of patterned performance. Note similarity in sonagrams of cries 6, 7, and 8. The variations of cry which occur with greater stress are also consistent. In this infant, the variations are in the form of attenuations and interruptions of the expiratory vocalization, without the imposition of tonal shift or turbulence noted in the other cry illustrations. Brief attenuation of vocalization, with slowing of frequency, is seen in cry 2 (at frame 223), cry 3 (frame 285) and cry 5 (frame 340). It is shown in prolonged gradation and detail in the last one and a half seconds (frames 228-260) of cry, during which the basic frequency of cry, indicated by vertical striations, is slowed progressively to less than 100 cps. This process of interruption is seen with little or no attenuation in cry 4 (at frames 309-314) and cry 5 (frames 345-349). Another individual feature of this infant's cry is that of extension or "overflow" of his vocalization into inspiration. This is seen slightly in cry 2, more in cry 3, and in remarkably consistent schedule and phonatory pattern in cries 4-8.

This infant's upper pharynx and body of palate move little, and his palate is not approximated to pharynx wall. The tongue is grooved deeply in middle during cry. The movements of the lower pharynx are widely ranging with much antero-posterior movement of pharynx wall and tongue, and changes in cephalo-caudal length of pharynx. His immaturity is indicated also in the difference in degree of these motions of expansion and constriction with degree of effort of cry. This variation is shown particularly in the extent of cephalad motion of the lower pharynx during cry. The composite elements of hyoid, larynx, and the hypopharynx are displaced cephalad farther during these more effortful cries (compare frames 215, 220 and 223 of cry 2 with frame 370 of cry 6).

The schedule of these changes in pharyngeal contour are only generally associated with the vocal phenomena. The gross dorsal displacement of palate and ventrad displacement of dorsal pharyngeal wall with cry expiration, and the converse direction of motions with

inspiration, occur slowly, in contrast with the abrupt onset and termination of the expiratory cry. The transient attenuation and interruption in sound in mid-phonation are associated with no separable pharyngeal maneuver. Nor is the diminution of sound concluding cry 2. The differences in the phonated inspiration in cries 2 and 6 are associated with no distinguishable difference in inspiratory pharyngeal contours. Accordingly, these expiratory and inspiratory vocal modulations are interpreted as laryngeal in origin (see text).

The egressive phases of the sequence selected for Figure 2 are examples of basic cry. They occur in this term-born infant at moderate arousal. They are comparatively free of superimpositions of phonatory distortion. The tone rises at the onset and is remarkably stable throughout phonation. In Figure 3 (of the same infant), we see this remarkable stability of cry, and consistency of pattern of separate cries in cries 6, 7, 8, and 9. Note the similarity of intra-esophageal pressure variations of these four cries and the general approximation of increase of pressure with onset of cry and decrease of pressure with termination of vocalization in expiration and overflow of vocalization into inspiration. The pharynx undergoes considerable change of contour (Figure 3, in frames 55-67 of cry 3, of Figure 2, and in frames 123-125 of cry 7, of Figure 3), with little effect upon the stable vocalizations.

With greater effort, reflected in Figure 3 in greater intra-esophageal pressure, the phenomena of tonal shift appear. In general, shift from basic tonal pattern to a shifted tone is in similarity of pattern in the cries of a single infant and occurs earlier in the more effortful cries. Each of these phenomena of shift is initiated and terminated in a peculiarly abrupt fashion, with transition time of less than 20 msec. This remarkably rapid change, which is clearly in excess of usual modulation, is termed paroxysmal.

Such abrupt vocal phenomena may be intermixed with turbulence appearing in these sonographic illustrations as blurred or dysharmonic activity (Figure 3A, cries 5 and 10-17, and Figure 4). The turbulence variably overlaps the tonal shift of the adjacent basic harmonic patterns. In the instances in which turbulence occurs alone, without tonal shift, the progressions between sustained tone and turbulence are not of the abrupt paroxysmal character. It is inferred, accordingly, that turbulence is imposed upon cry by a qualitatively different mechanism, compared with paroxysmal shift and silence.

SUMMARY

In summary, the newborn's crying performance is a basic antecedent of the articulations and modulations of speech. It is important to recognize that the laryngeal coordination of infant cry is essentially a mature coordination, capable of accomplishing a stable vocalization, with well-organized and well-modulated harmonic patterns. The newborn's laryngeal vocalization is immature in its liability to extension into the succeeding inspiration and in its susceptibility to extraneous impositions of turbulent sounds and shifts and silences.

In these perspectives, post-natal development of vocal expression may be described as the addition of upper pharyngeal and oral modulations to an already well-developed laryngeal vocal coordination. This whole composite of function is progressively integrated, so that the discrepancies in schedule of the respiratory motions of larynx, pharynx, and trunk found in infants are no longer discernible. The whole of respiration is thus drawn into this integrated performance. As a reflection of progressive stabilization of the central nervous system, these impositions of tonal shift, silence, and turbulence no longer occur in normal mature subjects.

REFERENCES

- BOSMA, J. F., and LIND, J., Upper respiratory mechanisms of newborn infants: a clinical essay. *Acta Paed.*, Suppl. 135, 32 (1962).

DENTAL RESEARCH – A CONTEMPORARY VIEWPOINT

EDWARD J. DRISCOLL

National Institute of Dental Research, Bethesda, Maryland

I will attempt to paint a word picture of the National Institute of Dental Research's interesting though brief history. It will be a narrative depicting our research efforts from our humble beginning, a little more than 30 years ago, to our respectable position on the campus of the world's most renowned research institution.

The parent organization, The National Institutes of Health (NIH), has been in existence since 1887. The name by which it was first popularly known was the Hygienic Laboratory. Its direct descendant as an Institute is the National Institute of Allergy and Infectious Diseases, which celebrated its 75th anniversary in November 1962.

Dentistry's participation in national health research began in 1931 when the Surgeon General appointed the late H. Trendley Dean to the staff of the Dental Hygiene Unit of the Division of Pathology and Histology of the infant NIH. Dean was assigned specifically to study the epidemiology of mottled enamel.

We are familiar with the evolution of these studies which soon disclosed the inverse relationship between fluorosis and dental caries. The investigation paved the way for the fluoridation of community water supplies, the only large-scale caries prevention and control measure yet available.

The story is so familiar that no further elucidation is necessary, save to make one relevant comment. The fluoride studies were conducted without electron microscopes, without x-ray diffraction studies, without sophisticated microbiological and biochemical techniques, and without the epidemiologist's "omniscient wand," the computer. Dentistry's most significant contribution to 20th century health science was the result of a pregnant idea in the minds of men with vision and perseverance.

The indispensable tools of modern science have expanded and improved our knowledge, but every researcher can take hope and encouragement from the success of those who made their significant discoveries without the benefits of today's advanced technology.

The NIDR was formally established by an Act of the 80th Congress, Public Law 755, passed in 1948. An appropriation of \$100 000 for architectural fees

and \$2 000 000 for construction of a suitable laboratory building was authorized, but no bill was passed for the monies needed. During the 10 years of delay which followed, NIDR researchers used many laboratories in other NIH buildings. By August 1958, when the appropriation was passed by Congress and signed by the President, the architectural fees had risen to \$200 000 and the construction costs were \$3 777 000 — almost double the 1948 estimates.

The building became a reality and was dedicated in May 1961. It houses a relatively small administrative staff and the most modern, efficient, and best-equipped dental research laboratories in the world, with a staff of approximately 250, of whom 91 are in the professional category.

The amount and complexity of today's research activity makes a brief recounting of accomplishment impossible. The essential points will be related to you by others. However, some of the essential differences from the research of 30 years ago are worth noting, as well as the trend for the foreseeable future.

The budget has been an expanding one, particularly in grants for research and training. The extramural grants program has grown from no money in 1948 (out of a total budget of \$429 000) to a \$15 741 000 share, or 80 per cent of the total NIDR budget (\$19 445 000) in fiscal year 1963.

One of the most significant features in our 32-year history has been the growth and development of our professional staff from the one nonspecialist dentist of 1931 to the almost 100 who comprise our professional complement today. These scientists represent many disciplines: 46 dentists, 19 physicians, and 33 Ph.D.'s whose fields range from biochemistry to pathology. It is immediately recognizable that the dentists are outnumbered in their own Institute by the Ph.D.-M.D. combination. In my estimation, this is a healthy sign indicating that we in dental research no longer consider dental caries and periodontal disease as special dental entities but recognize these and all other oral diseases, anomalies, injuries of the teeth, jaws, and associated structures as disabilities of the total man and not of a separate organic system. In this recognition we have enlisted the other medical and scientific specialties in our more comprehensive research undertaking. In the full utilization of all these biological specialties, dental research is taking its rightful place with the other health sciences.

I have purposefully neglected mentioning any specific research accomplishment in either our basic or clinical investigations. I have also purposefully neglected mentioning research, basic and applied, in the field of cleft lip and palate. These subjects will be discussed by the highly competent people who follow me.

It would not be out of order, however, for me to remark briefly on some of the more promising research accomplishments in our basic and clinical sections about which you are not likely to hear. In the field of biophysical investigation, which uses such technics and tools as electron microscopy and x-ray diffraction, microradiography, densitometry, and spectrophotometry, significant work on the structure and physical properties of mature human enamel

has progressed with rather satisfying results. Since the enamel is the only major physical bulwark to the initiation and progress of dental caries, the implication of these findings is self evident.

Interesting and important studies in germfree animals have shown that caries, in two species of animals, is a transmissible and infectious disease and that species-specific microorganisms are responsible. Plans are now under way to determine whether caries in man has a similar infectious and transmissible character and, if this is so, why can't we give consideration to the treatment of caries by sustained antibiotic and other antimicrobial chemotherapeutic measures.

I do not wish to mention certain areas of accomplishment and neglect others of equal importance, but the list is long and I cannot cover all the achievements. We have new knowledge of enzyme and protein chemistry, of the nature of oral ulcerations, of the relationship of oral bacteria to dental calculus and periodontal disease, and of the effect of high speed dental instrumentation on the tooth pulp. The list could be considerably extended.

Today's research attitude emphasizes a multidisciplinary and many-faceted approach. As an example, I might mention current research in cleft lip and palate.

We are, of course, interested in the surgical and prosthetic considerations of these conditions. But we give equal importance to speech, hearing, pharyngeal function, and the total rehabilitation of the patient physically, physiologically, and psychologically. Even more important, we are concerned with the basic research to which we turn in an effort to learn the reasons — environmental, genetic, and otherwise — for the origin of the clefts, the time *in utero* of their inception and, in fact, all considerations which might lead to a better understanding of the problem.

It is known that hypoxia, abnormal pressure, certain viruses, and other environmental influences, when they occur at or near the time of fusion of the orofacial components, may result in clefts. The genetic picture is also being thoroughly studied by epidemiological methods, both for possible overt causes and for the subtle associated micro conditions in the normal carriers of the defective genes.

Armed with a more thorough knowledge regarding all the discernible facets of etiology, it is not unrealistic to anticipate some amelioration in the incidence of this crippling orofacial deformity.

With a more accurate knowledge of all dental diseases through research and the full use of our space age technology by 20th century brains and by men of vision, the answers to oral health problems can be found.

THE TECHNIQUES OF CLEFT PALATE SURGERY

JOHN MARQUIS CONVERSE

New York University, New York, New York

Today, cleft palate surgery can be performed at an early age without undue difficulty. In over 90% of the cases there is uncomplicated healing, 60% of the patients developing adequate speech (Reidy, 1959; Nylen, 1961). Velopharyngoplasty has further improved these results. Some authors claim to have obtained "normal speech" in 90% of the patients operated upon following velopharyngoplasty. Gone forever, fortunately, are the days of uncertain surgical techniques, poor anatomical results, secondary deformities — especially in the maxilla, a non-negligible mortality, and disappointing speech results. Improved results have followed a better understanding of the surgical principles involved and the application of the techniques of plastic surgery to cleft palate surgery, improvement in anesthesiology, and the advent of antibiotics. Of extreme importance has been the role of the speech pathologist in diagnosis, speech assessment, and therapy. Both surgeon and speech pathologist have been assisted in recent years, in the study of velopharyngeal closure during sound production and connected speech, by improved clinical methods, cephalometry, cinefluoroscopy, and sound spectography.

It is generally agreed that the quality of speech depends both on obtaining an anatomically restored and functioning soft palate and upon the development and mobility of the pharyngeal muscles. Other factors are important, such as the level and the type of speech development at the time of operation (in patients in whom speech has developed prior to surgery), the patient's acuity of hearing and his intelligence, his basic personality, and the environment in which he lives. This paper is concerned primarily with the methods which have developed for restoring an adequately functioning soft palate capable, with the pharyngeal musculature, of providing the patient with adequate velopharyngeal competence. It is the purpose of this paper to describe the progressive evolution toward present day techniques. The pre and post operative management, equally as important as the actual surgery, are omitted for the sake of brevity.

DISCUSSION

The Development of Cleft Palate Surgery

A dentist from Rouen, France, has been credited with the first attempt at surgical closure of a cleft palate (Langenbeck, 1861). Le Monnier (circa 1766) inserted sutures in the soft palate, then freshened the margins of the cleft with a thermocautery. Successful closure of the soft palate (staphylorrhaphy) was

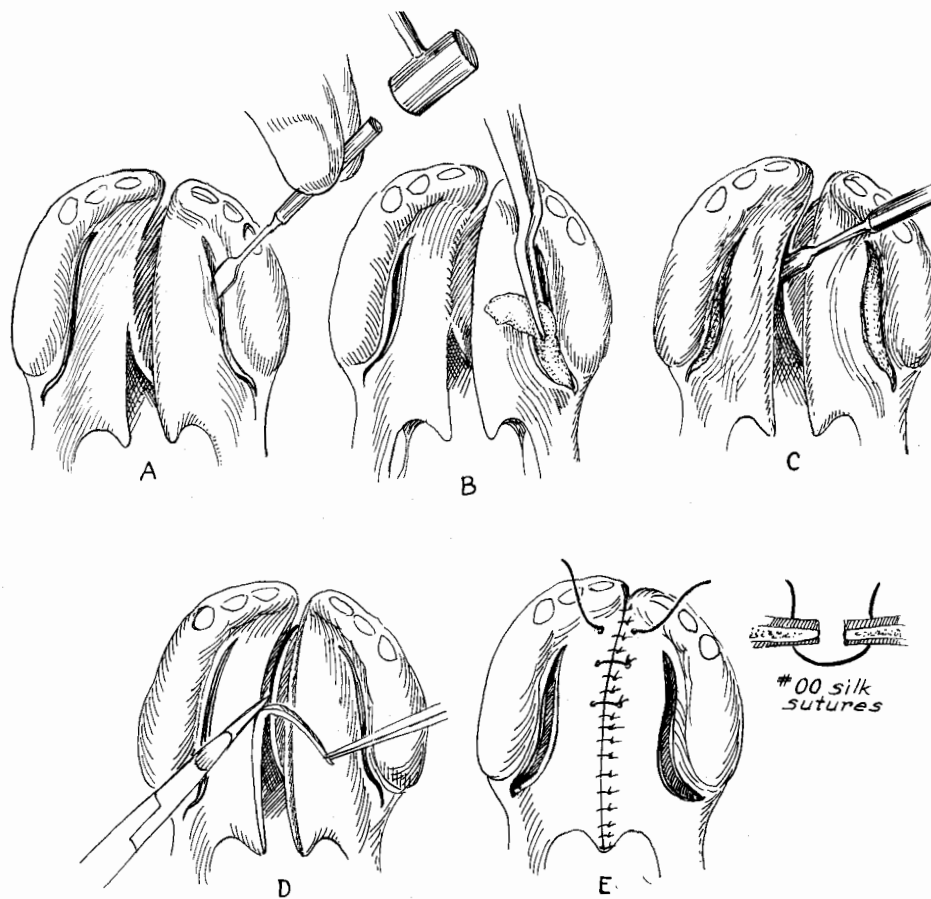

FIGURE 1. The Dieffenbach bone flap operation (after Peer, L.A., *The Surgical Clinics of North America*, 39:313, 1959).

A. Section of the bony palatal shelf through the lateral mucoperiosteal incision in a first stage operation.

B. Oxycel cotton is inserted and held firmly until bleeding has stopped.

C. In a second stage operation the base of the vomer is severed from its attachment to the palatal shelf on the right side.

D. Mucous membrane is resected from the edge of the cleft.

E. The sectioned palatal shelves are mobilized medially and approximately by means of through and through sutures (see insert) placed through drill holes in the bone and sutures placed through the edges of the palatal mucous membrane.

described by von Graefe (1817) in Germany, Roux (1819) in France, and John Collins Warren (1828) in the United States. Closure of the hard palate (urano-plasty) proved to be a more difficult problem and Dieffenbach (1845) devised an operation consisting in making lateral incisions through the mucoperiosteum and cutting through the bony palatal shelves with an osteotome in order to obtain the medial displacement of the palatal bone. The Dieffenbach operation, often referred to as the bone flap operation (Figure 1), was employed in

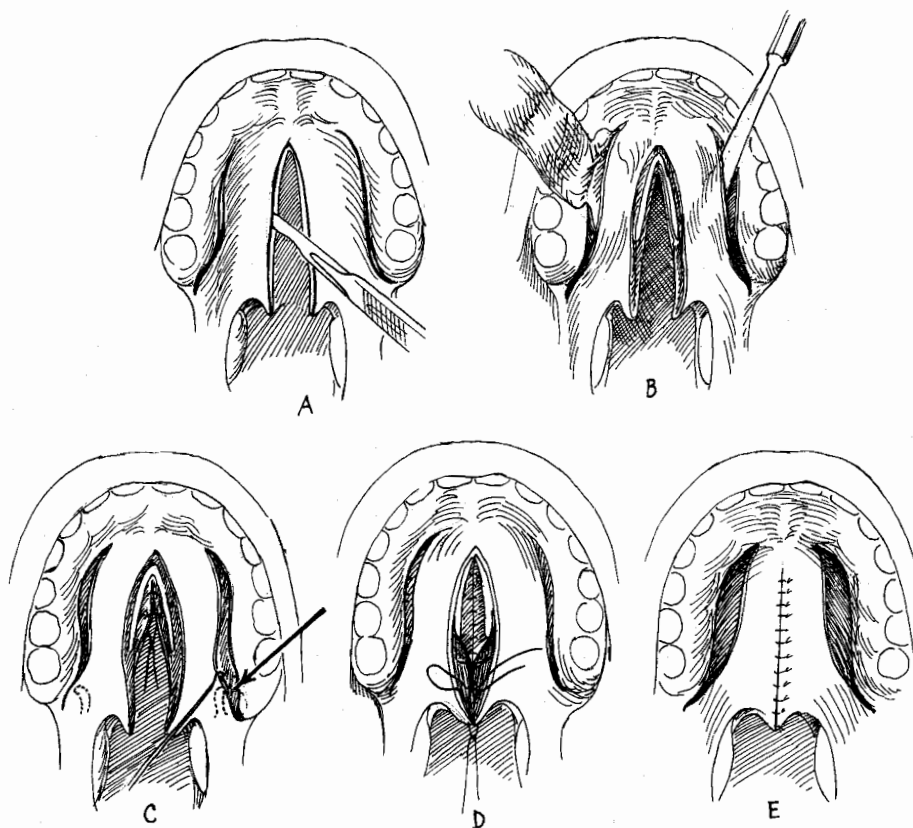

FIGURE 2. The Langenbeck Operation.

A. The mucous membrane is resected at the edges of the cleft and lateral relaxation incisions are made through the mucoperiosteum.

B. The mucoperiosteum is raised from the bony palatal shelves.

C. The neurovascular bundle is exposed at the greater palatine foramen (as indicated by the arrow). Various elective procedures are then done: fracture of the pterygoid hamulus, removal of the posterior wall of the greater palatine foramen, section of the palatine aponeurosis, subperiosteal elevation of the soft tissues over the medial surface of the medial pterygoid plate.

D. Suture of the muscle layer of the soft palate.

E. Operation completed after suture of the palatal mucous membrane.

the United States by Warren Davis (1928). Currently, it is utilized by Hyslop and Wynn (1952) and Peer (1959).

Langenbeck (1861) described the raising of a mucoperiosteal flap mobilized medially after making lateral relaxation incisions extending from the pterygoid hamulus, posteriorly, to the canine tooth, anteriorly. Surgeons had attempted to separate the mucous membrane from the periosteum and Langenbeck appears to have been the first to emphasize the need for including the entire mucoperiosteum in the flap. The operation of Langenbeck utilizing a bipedicle

flap with anterior and posterior attachments, avoiding injury to the palatine neurovascular bundle and attaching the palatal flaps to the denuded septum, became widely accepted. The Langenbeck operation with various modifications is still widely employed at the present time (Figure 2).

Efforts had been made to close defects of the hard palate by the bone flap method of Dieffenbach and Warren. Brophy (1915) advocated compression in the treatment of clefts. He inserted silver wire sutures passed in the coronal plane. The procedure was done as soon as possible after birth. Brophy's method, however, was discarded rapidly as it caused atresia of the maxilla. Veau (1922), after a series of 77 cleft palate operations, became dissatisfied with the results of the Langenbeck operation. Veau was critical of the procedure used by surgeons who followed the Langenbeck technique, many of whom sectioned the muscles to facilitate the approximation of the edges of the cleft. Fergusson (1844) had introduced the principle of cutting the muscles of the palate in order to provide relaxation and facilitate healing. He divided the palatopharyngeus, the palatoglossus, and the levator palatini muscles on each side. Fergusson does not mention section of the tensor palatini muscle although it is probable that he also severed this muscle as advocated by Liston (1846). Billroth (1871) is the first to cast doubt upon the advisability of sectioning the musculature of the soft palate; as an alternate

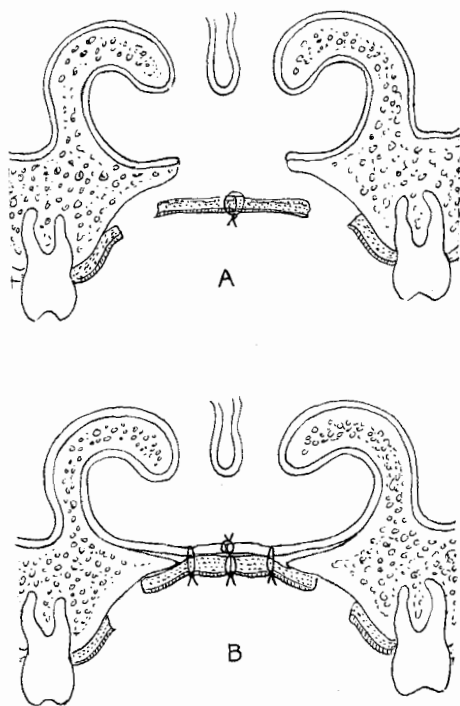

FIGURE 3. Veau's criticisms of the Langenbeck operation (from Converse, J. M., Victor Veau (1871-1949), The contributions of a pioneer, *Plast. & Reconstr. Surgery*, 30:225, 1962).

A. Veau's illustration of the dead space above the Langenbeck flaps and the raw surface on the nasal surface.

B. Veau's illustration of his own operation with palatine flaps sutured to nasal flaps thus eliminating dead space and raw surface.

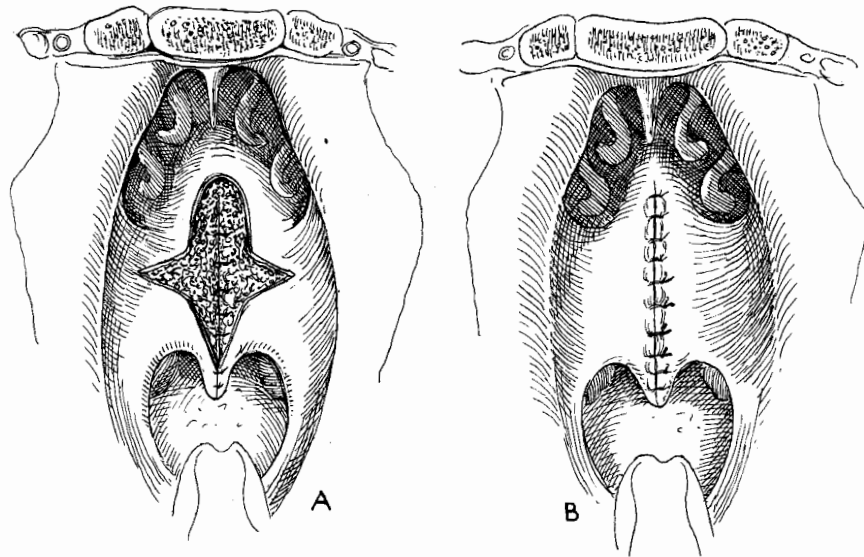

FIGURE 4. Veau's diagram illustrating:
 A. The raw surface on the nasal aspect in the original Langenbeck operation.
 B. Shows the elimination of the raw surface by suture of the nasal flaps.
 (from Converse, J. M., Victor Veau, (1871-1949). The contributions of a pioneer, *Plast. & Reconstr. Surg.*, 30:225, 1962).

procedure to obtain relaxation of the tensor, he suggested fracture of the hamulus, a procedure still widely practiced today. Veau also criticized the void between the lowered flaps of mucoperiosteum and the hard palate which occurred in the Langenbeck operation (Figure 3). Infection, inevitable in this

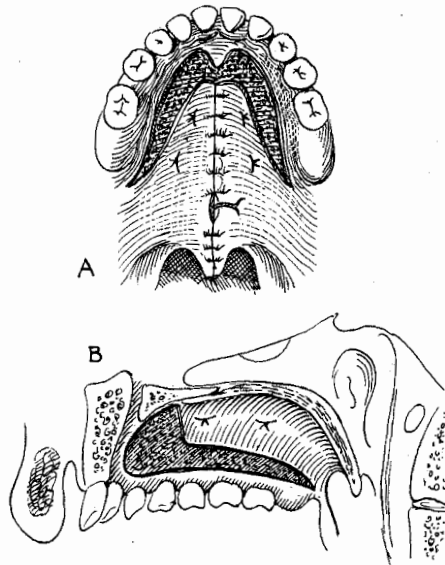

FIGURE 5. The Veau flap. (from Converse, J. M., Victor Veau (1871-1949). The contributions of a pioneer, *Plast. & Reconstr. Surg.*, 30:225, (1962).

A. The flaps, detached anteriorly, based posteriorly upon the palatine vessels, permitting elongation of the soft palate. The twisted wire shown in the soft palate illustrates Veau's metallic pull-out wire looped through the musculature of the soft palate.

B. Free anteriorly, the Veau flap can be fitted to the concavity of the palatine arch and sutured to the nasal flaps, thus eliminating dead space.

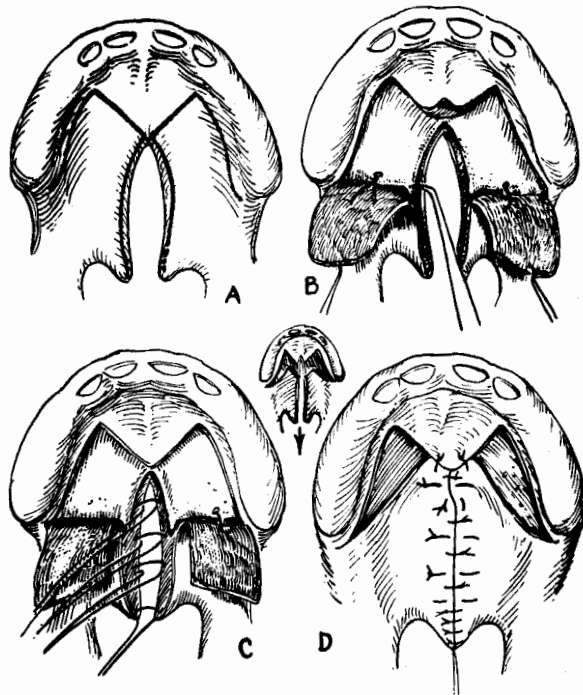

FIGURE 6. The Veau-Wardill-Kilner (after Holdsworth, W. G., *Cleft Lip and Palate*, 3rd Ed. Grune and Stratton Inc., N.Y. 1963).

- A. Outline of the flaps.
- B. The flaps are raised with palatine vessels preserved at the base of the flaps. The mucoperiosteum on the nasal aspect of the palatine shelves is raised.
- C. Suture of the nasal mucoperiosteum.
- D. Position of the flaps at the end of the operation.

pre-antibiotic period, occurred in the raw tissue and spread to the nasal surface of the soft palate, frequently leading to the disunion of the flaps (Figure 4). He also criticized the tension under which the Langenbeck bipedicle flaps frequently were sutured.

Veau introduced a new design of the flap. The palatal flaps were detached anteriorly and vascularized only by the posteriorly situated palatine vessels. The flaps, completely free, except at the posteriorly based pedicle, could be raised and moved medially and upward and applied against flaps of nasal mucoperiosteum thus eliminating the dead space and the raw surface on the nasal aspect (Figure 5). Veau emphasized the need for complete closure of the nasal flaps, a principle now also employed by the advocates of the Langenbeck operation (Figure 2C). Veau also emphasized the importance of approximation of the musculature of the soft palate, advocating muscle suture.

The Veau operation was modified by Wardill (1937) and Kilner (1938). A major advantage of the Veau flap was that it was detached anteriorly and could be moved more readily posteriorly. Wardill introduced a new design of flaps to close the hard palate (Figures 6, 7, and 8).

Another contribution made by Veau was the development of the vomer flap which facilitated the closure of the hard palate. Veau had made some attempt to utilize the oral mucous membrane to repair the cleft as advocated by the British surgeon Lane. The concept of utilizing the strong nasal mucop-

FIGURE 7. The Wardill four flap method (after Holdsworth, W. G., *Cleft Lip and Palate*, 3rd Ed. Grune and Stratton, Inc., N.Y. 1963).

- A. Outline of the flaps.
- B. The flaps are raised.
- C. Suture of the nasal layer and apposition of the anterior palatal flaps to the nasal flaps.
- D. Position of the flaps at the completion of the operation.

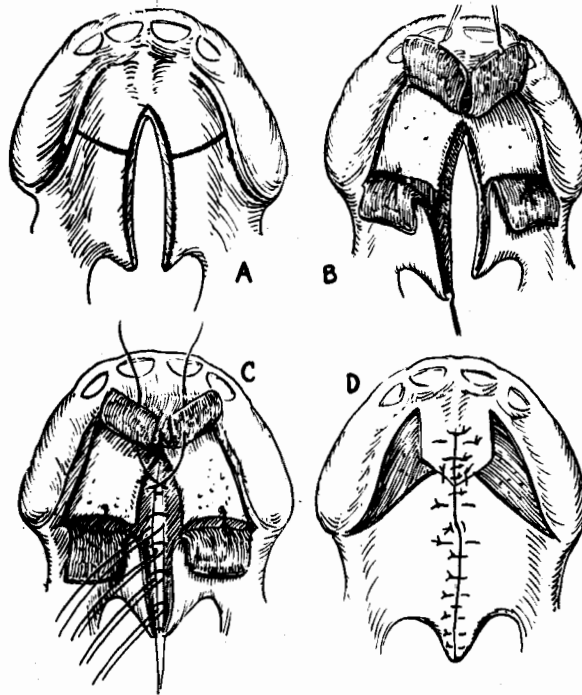

erriosteum that covers the vomer came as a follow up of these attempts. Thus, the vomer flap technique which was used by Veau in conjunction with the closure of the cleft lip came into existence (Figure 9). Reports between 1952 and 1960 by surgeons using Veau's method as well as the modernized Langenbeck and the Veau-Wardill-Kilner technique show primary healing in over 90% of the patients in large series. Veau reported that 70% of the patients treated during the first year of life had adequate speech. These results were so outstanding that the suggestion was made that competent nasopharyngeal closure was not required to the same degree in the French language as in the English and the German.

The Primary Cleft Palate Operation

Whether the cleft is of the secondary palate alone or also involves the primary palate, whether it be a cleft of the soft palate only or a cleft extending forward through the alveolar process, the most important aspect of the surgery from the point of view of speech is the reestablishment of a functioning soft palate, permitting velopharyngeal closure. Speech will be affected by the presence of an opening in the hard palate causing an oro-nasal communication; speech will also be affected by dental malocclusion which may occur as a result of maxillary maldevelopment.

Two techniques are widely used throughout the world for the closure of a cleft palate and the construction of a functioning velum: the modified

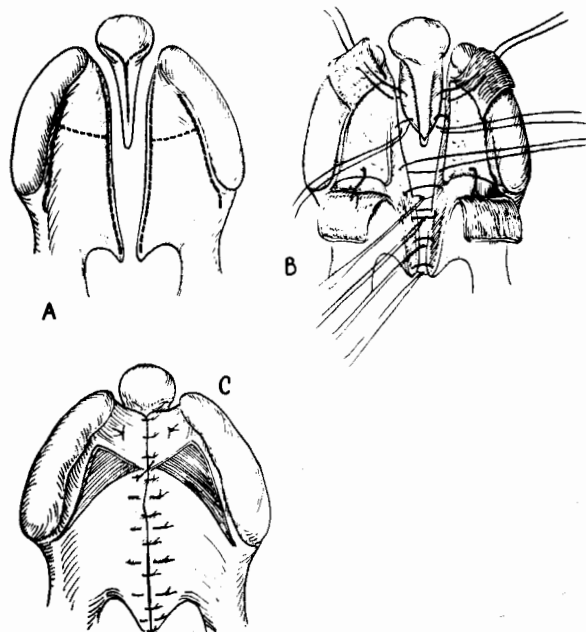

FIGURE 8. The Wardill four flap method in the bilateral cleft (after Holdsworth, W. G., *Cleft Lip and Palate*, 3rd Ed. Grune and Stratton, Inc., N.Y. 1963).

- A. Outline of the flaps.
- B. The flaps are raised.
- C. Position of the flaps at the completion of the operation.

Langenbeck (Figure 2) and Veau-Wardill-Kilner (Figures 6, 7, and 8) operations. Innovations have been made during the past 10 years on methods of reestablishing the continuity of the hard palate. Bone grafting has also been employed to reestablish the continuity of the bone.

After freshening the edges of the cleft by excision of the narrow strip of mucous membrane, flaps of muco-periosteum are raised from the palatal shelves on each side. In the Langenbeck operation, the mucoperiosteal flap is bipedicled; in the Veau-Wardill-Kilner procedure, the Veau flap is unipedicled.

The flaps are raised from the bone as far back as the posterior edge of the hard palate, care being taken to respect the integrity of the neurovascular bundle at the greater palatine foramen. At this point, the extent of surgery varies according to the operator. The posterior edge of the hard palate is exposed, the subperiosteal elevation being extended laterally to the medial pterygoid plate and hamulus. Some operators then continue the subperiosteal elevation from the medial pterygoid plate over its entire medial surface. The hamulus may be palpated and exposed and the tensor palatini tendon is seen in front of the hamulus, fanning out into the palatal aponeurosis. The tensor palatini tendon is divided with a knife blade by some; others prefer to fracture the hamulus and thus reduce the tension on the soft palate without severing the tendon. The palatal aponeurosis may be severed from its attachment to the posterior border of the hard palate, usually over a portion only of its line of attachment. In wide clefts, if relaxation is inadequate, the incision may be extended posteriorly to the hamulus through mucosa only and the tissue can be separated by gentle dissection with the finger although most operators feel this procedure endangers the muscles and is not advisable.

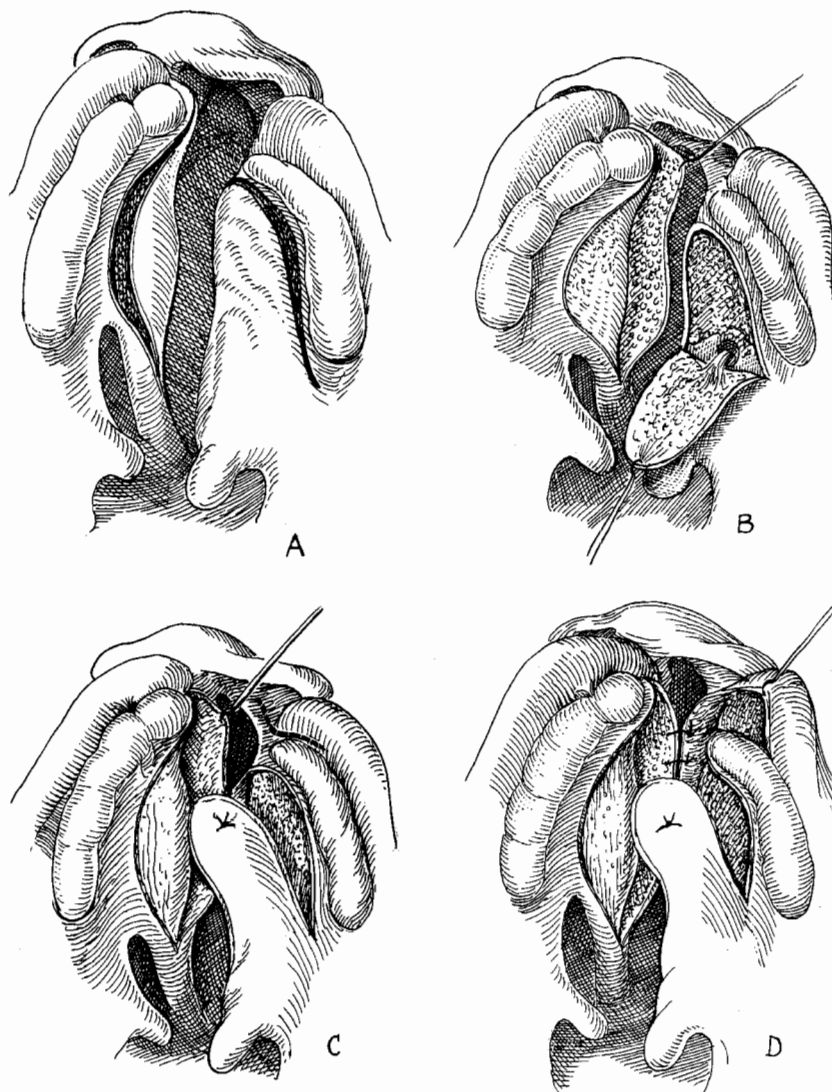

FIGURE 9. The vomer flap (from Converse, J. M., Victor Veau (1871-1949), The contributions of a pioneer, *Plast. & Reconstr. Surg.*, 30:225, 1962).

- A. The vomer flap and the palatine flap have been outlined and incised.
- B. The flaps are raised.
- C. The palatine flap is sutured to the vomer flap. The dotted line represents the outline of the incision in the buccal sulcus.
- D. Suture of the nasal mucous membrane between the alveolar arches.

Veau was opposed to severing the muscles and obtained closure without disturbing the tensor tendon or subperiosteal elevation along the pterygoid plate; he attributed his success to an encircling metallic suture through the muscles of the soft palate, a procedure abandoned by his successors. Hynes

(1955) also has emphasized the need for avoiding unnecessary disturbance of the structures of the soft palate; he does not fracture the hamulus and avoids dissection along the pterygoid plate.

The next most important step (so well emphasized by Veau) is the suture of the nasal mucoperiosteum. With a small elevator, starting at the posterior border of the hard palate and extending medially toward the spine and around the spine along the medial border of the cleft hard palate, elevation of the nasal mucosa is done over the entire nasal surface of the palatal shelves and on to the lateral walls of the nose. The mucoperiosteum of the septum may be raised to facilitate closure in a unilateral cleft when the septum is attached to one edge of the hard palate. When the septum lies free and unattached into the cleft, mucoperiosteum may be separated from either aspect of the septum. One cannot overemphasize the importance of careful closure and primary healing of the mucous membrane on the nasal side of the cleft. Scarring resulting from inadequate healing in this area is the major cause of post-operative shortening of the palate. Cronin (1957) raises nasal mucoperiosteal flaps in order to permit coverage of the raw area over the retroposed palatal tissue.

At this point in the operation, the flaps having been freed on the nasal as well as on the oral side, further retroposition is prevented by the neurovascular bundle penetrating the soft tissues of the palate at the greater palatine foramen. Limberg (1927) suggested a procedure which is of some help in allowing further lengthening of the palate. It consists of removal of the posterior wall of the greater palatine foramen, allowing the neurovascular bundle to fall backward.

There is a growing body of opinion among cleft palate surgeons that the Veau-Wardill-Kilner operation which frees the palatal mucoperiosteal flaps from their anterior attachments permits a greater degree of palatal lengthening than the Langenbeck bipedicle flap method.

Closure Of The Hard Palate

✓ A major advance was provided by the introduction of Veau's vomer flap technique. Veau utilized the vomer flap to obtain surgical closure of the anterior portion of the hard palate at the time of the closure of the cleft lip. The vomer flap technique combined with the Wardill "four-flap" technique opened the way to the development of the newer techniques of bone grafting the hard palate because is provided the tissue necessary to obtain soft tissue continuity and thus made bone grafting possible.

Interest in the reestablishment of the bony continuity of the hard palate arose from the displacement of the alveolar segments in both the unilateral and bilateral clefts. The median collapse of the lateral alveolar segment behind a protruding premaxilla in the bilateral cleft, and the median collapse of the alveolar segment lateral to the cleft in the unilateral cleft, are deformities seen in the newborn prior to surgery. Surgical closure of the lip has a beneficial influence on the alveolar segments (for example by aiding in the

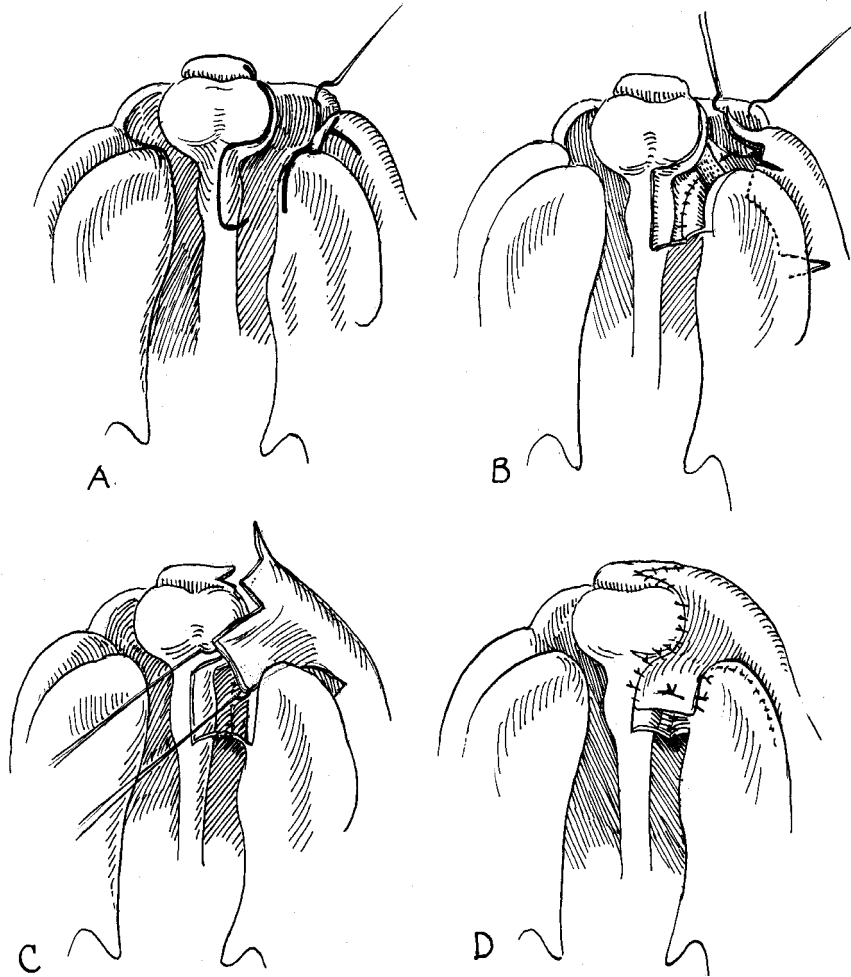

FIGURE 10. Primary closure of alveolar cleft, a preliminary step to bone grafting.
 A. Outline of incisions.
 B. Vomer flap utilized to form the nasal floor; the labial flap is raised.
 C. Labial flap placed over the palatal defect.
 D. Flaps in position at the completion of the operation (after Schrudde and Stellmach, 1959).

retrusion of the premaxilla), but it also has been held responsible for malalignment of the alveolar segments and overriding which may be responsible for atresia of the maxilla. In order to prevent these complications, Schmid (1955), Nordin and Johansson (1955), Schrudde and Stellmach (1959), Johansson and Ohlsson (1961), Backdahl and Nordin (1961), and Brauer, Cronin, and Reaves (1962, 1964) have described techniques for reestablishing the soft tissue continuity across the cleft and bone grafting employing either

tibial or costal bone (Figure 10). These surgical procedures have been undertaken in conjunction with prosthetic realignment of the maxillary segments. The order of the procedures has been varied. Prosthetic realignment has been done in the first stage, closure of the cleft lip and of the cleft of the hard palate in a later stage, followed by a third stage consisting of bone grafting. In another variation, the cleft lip and cleft of the hard palate have been closed in a first stage; in a later stage, bone grafting is done and prosthetic realignment is undertaken only after consolidation of the bone graft. Some operators have undertaken the bone grafting procedure in conjunction with the soft tissue closure.

It is claimed, and it is probable, that efficient realignment of the maxillary segments and bone grafting will minimize later development of dental malocclusion. This is the first factor toward improvement of speech, but a second and more important advantage of bone grafting the hard palate is the following. When, at a later date, surgical closure of the cleft soft palate is done, a "push-back" of the palatal mucoperiosteal flap can be achieved by the Veau-Wardill technique with greater efficiency because the prior closure of the hard palate by bone graft eliminates the fear of perforation through the hard palate resulting from recession of the flaps.

Secondary Operations

With the considerable improvement that has been obtained in cleft palate surgery — primary healing usually resulting in over 90% of the patients and over 60% of the patients having adequate speech following surgery — many of the secondary operations are no longer necessary. The improvement in surgical results has also obviated the need for the use of obturators and speech bulbs although these appliances are still indicated in specific cases. Obturators also may be employed as a diagnostic aid prior, for example, to the planning of a pharyngeal flap operation.

The remaining 40% of patients who do not develop "adequate" speech following surgery may be improved by speech therapy, by secondary operations involving the soft palate and pharynx or, as is usually the case, a combination of speech therapy and secondary surgery.

The speech pathologist deals with many factors in helping the patient to surmount his speech handicap. Among these are the patient's own ability to acquire correct speech habits. The speech pathologist's task is facilitated if the patient has adequate function of the soft palate, posterior and lateral pharyngeal walls, a favorably shaped nasopharynx, and satisfactory muscular and sensory function.

VELOPHARYNGEAL CLOSURE

A primary consideration is that the patient have competent velopharyngeal closure. Surgical procedures are available to improve the various portions of the velopharyngeal mechanism.

Passavant (1862) appears to have been the first to describe the nasal intonation, so characteristic of patients who have undergone unsuccessful cleft

palate surgery, due to inability of the soft palate to reach the posterior pharyngeal wall. He described the contraction of the superior constrictor muscle on the posterior pharyngeal wall which, he noted, produced a ridge which assisted contact between the soft palate and the pharyngeal wall. This ridge is referred to as Passavant's ridge. Passavant unsuccessfully attempted to increase the prominence of the ridge by a surgical procedure consisting in the plication of a quadrilateral flap of pharyngeal tissue. These attempts by Passavant at surgical improvement were unsuccessful. It is generally considered today that Passavant's ridge is not a static structure but is, instead, a dynamic formation produced by the contraction of a portion of the palatopharyngeus muscles.

Passavant had emphasized that the ridge on the posterior pharyngeal wall was essential for velopharyngeal closure in the production of normal speech. This concept was challenged by Veau and Borel-Maisonny (1943), and Calnan (1956, 1957) concluded that the forward projection of Passavant's ridge in the normal subject occurred infrequently and was "too slow, too low, too inconsistent and too easily fatigued to be of essential importance in the speech mechanism."

Lateral Pharyngeal Wall Movements

Movements of the lateral pharyngeal wall play an important role in the closure of the velopharynx. During speech, movements of the posterior pharyngeal wall occur and the lateral pharyngeal wall moves medially. Interest has been aroused in recent years concerning the importance of the movements of the lateral pharyngeal wall in assisting in velopharyngeal closure. It has been thought by some that improvement following a pharyngeal flap operation, a procedure described later, is due in part to the narrowing of the pharynx and to the medial approximation of the structures following transfer of the flap of posterior pharyngeal tissue.

Size of the Nasopharynx

The size of the nasopharynx and the presence of adenoid tissue in the nasopharynx have also been of considerable interest. It has been noted in cleft palate patients that the lateral dimensions of the nasopharyngeal area are greater than the anterior-posterior or vertical dimensions. Veau, Borel-Maisonny, and Misset (1937) after studying several hundred patients with lateral roentgen films found an enlarged nasopharyngeal cavity in 7.5% of the cases. A tendency toward an increase in the lateral dimensions of the nasopharynx was found in later investigations by cephalometry and tomography by Subtelny (1955), Azzolini (1955), and Calnan (1959).

Nasality is further increased by an oversized nasopharyngeal vault which acts as a resonating chamber for the lower overtones. Hynes (1953) has pointed out an analogy with musical instruments: A large resonating chamber, such as a bassoon, accentuates the lower overtones in contrast to a small resonating chamber, such as the oboe, which has high pitch and accentuated higher overtones.

Adenoid tissue has long been considered important for velopharyngeal closure especially in children. Cephalometric studies have confirmed this concept (Pruzansky, 1953; Calnan, 1953; Hagerty and Hoffmeister, 1954; and Ricketts, 1954). Subtelny and Koepp-Baker (1956) noted that the soft palate had to traverse a greater distance after adenoidectomy in order to achieve velopharyngeal closure. They reemphasized the need for partial adenoidectomy when adenoid tissue impedes ventilation of the Eustachian tubes.

Muscular and Sensory Function

Veau (1931) stated that when one considers the important function of the soft palate in the young infant, who suckles or sucks whenever he is not asleep, one can predict the relatively large size of the muscles of the soft palate at that age.

"In the cleft velum all the muscles exist; they are modified because of the midline loss of continuity, but they are all there in their entirety. There has been a lot of talk about the atrophy of the muscles of the soft palate. This fact has especially been invoked by surgeons to explain or to excuse functional failure in staphylorrhaphy. My own opinion is that this atrophy is not a primary congenital state, it is a physiologic atrophy secondary to the anatomic state of the cleft palate," Veau stated. He said that examination of the fetus shows relatively large size of the muscles of the soft palate; in the fetus with cleft palate, the muscles have a similar size.

Veau (1931) stated that the shortness of the cleft soft palate was caused not by absence or inadequacy of the musculature but by the presence of the cleft which interrupts the continuity of the musculature and of the sling which normally pulls the soft palate backward toward the posterior pharyngeal wall. Browne (1935) described the nasopharyngeal sphincter as consisting of two interacting slings. One can conclude, therefore, that successful surgery restores the continuity of the musculature and the interplay of the slings.

While the categorical views of Veau are not universally shared, the fact remains that there is little evidence today in favor of the existence of hypoplasia of the musculature of the cleft palate. Li and Lundervolde (1958) and Broadbent and Swinyard (1959) in an electromyographic investigation demonstrated that the two most important muscles for velopharyngeal closure, the levator and the tensor palatini muscles, function normally. Whether the long immobile palate, incapable of competent velopharyngeal closure, can be explained on the basis of muscular hypoplasia, damage to the musculature during surgery or its blood supply or innervation are still subjects for conjecture. The sensory innervation can be damaged in cleft palate operations. Browne (1957) states that the anesthesia of the soft palate after operation soon disappears and is of no clinical significance. Broadbent and Hochstrasse (1959) noted that the secretory activity was markedly diminished in two patients with cleft palate who had been operated on at the age of 20 months and in whom the neurovascular bundle had been sectioned on one side.

Velopharyngoplasty

Surgical procedures to improve velopharyngeal competence may be divided into four groups:

- 1) The palate is lengthened in order to improve velopharyngeal closure.
- 2) The soft palate is joined directly, or by the intermediary of a flap to the posterior pharyngeal wall.
- 3) The posterior pharyngeal wall is displaced forward to meet the soft palate by pharyngoplastic surgery.
- 4) The fourth type of procedure consists of an attempt to increase the forward projection of the posterior pharyngeal wall by implantation of viable tissue or of an inert substance.

Lengthening the Palate

In describing the methods employed for the surgical closure of the cleft palate, emphasis was laid upon efforts to lengthen the palate as well as to provide surgical closure of the cleft.

Of the methods developed during the last 40 years to obtain surgical lengthening of the palate, two merit special mention. Both of these methods were employed to lengthen the soft palate following failure of the primary operation. Gillies and Fry (1921) achieved closure of the soft palate at the expense of the tissue covering the hard palate; resulting defects in the hard palate were then closed by an obturator. The second widely used procedure is that developed by Dorrance (1925, 1930) and Dorrance and Bransfield (1946). Dorrance called his operation the push-back operation and employed it as a secondary procedure to obtain palatal lengthening. When there was a cleft of the soft palate only, Dorrance made a circular incision immediately lingual to the alveolar process raising the mucoperiosteum as far back as the posterior border of the hard palate and severing the greater palatine vessels in a first stage operation. The flaps were sutured back into position; the purpose of this operation was to enhance the blood supply to the mucoperiosteal flap. If he felt that the flap would be deficient in epithelial lining on the nasal side, Dorrance placed a skin graft over the raw surface of the raised mucoperiosteal flap, usually in a second operation. In a third operation, after raising the flap, severing the palatine aponeurosis, subperiosteally elevating the tissue on the medial aspect of the medial plate of the pterygoid process and fracturing the hamular process, the cleft in the soft palate was sutured (with suture of the muscle layer) and the pushback procedure completed. Dorrance adapted his operation to cases in which there was also a cleft of the hard palate, closing the hard palate by means of a vomer flap in a preliminary stage (Figure 11).

✓ While the Dorrance type of palatal lengthening operation provided length it did not remedy the essential defect which is the deficiency in muscle tissue. It has long been observed that short palates with good muscle function provide velopharyngeal closure more efficiently than in long palates with poor muscle tone. Marino and Segre (1951) combined the Dorrance push-back operation with the pharyngeal flap; Conway and Goulian (1960) employed a similar

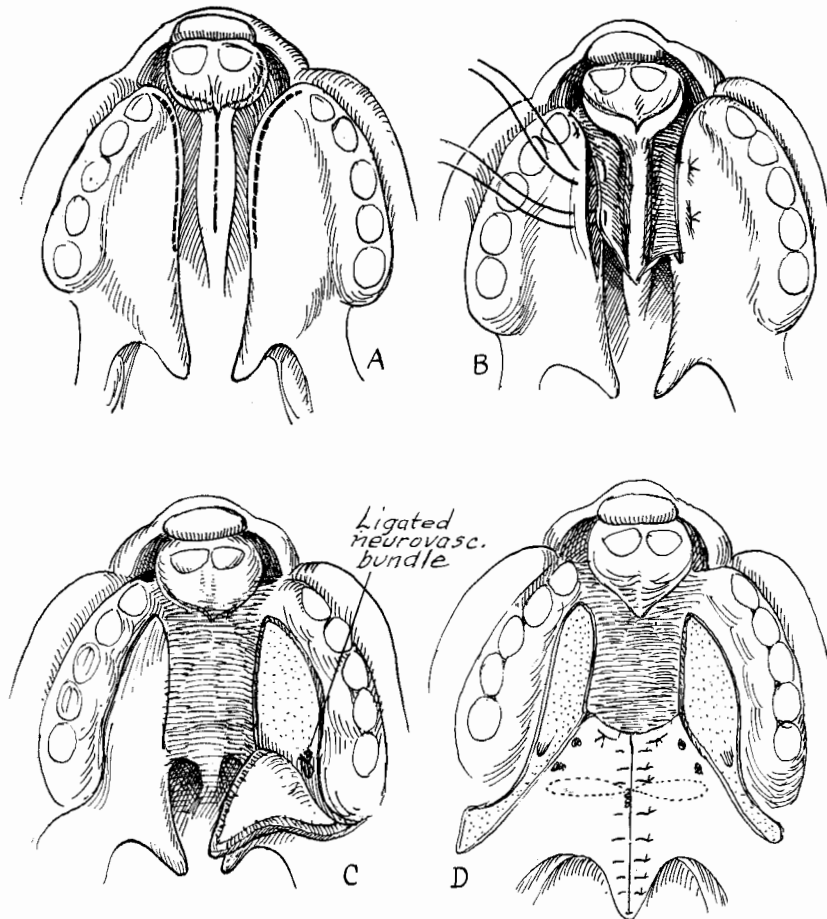

FIGURE 11. The Dorrance push-back operation in the bilateral cleft.

A. Outline of incisions.

B. Closure of the hard palate by means of vomer flaps.

C. After secondary epithelization of the raw surface of the vomer flaps, palatal flaps are raised, the neurovascular bundle sectioned and ligated at the greater palatine foramen, and the raw surface of the flaps is covered with a split-thickness skin graft. The flaps are replaced.

D. Position of the flaps at the completion of the operation in a later stage.

combined procedure. Dorrance's pushback operation has been largely superseded by the pharyngeal flap operation which not only provides pharyngeal fixation of the soft palate but also adds muscle tissue to the velum. If additional lengthening is required, it is usually achieved by a concomittant Veau-Wardill operation (Figure 12).

The Pharyngeal Flap Operation

The pharyngeal flap operation consists of transplanting a flap of mucous membrane and muscle from the posterior pharyngeal wall into the soft palate (Figure 12). The pharyngeal flap operation has become the most popular

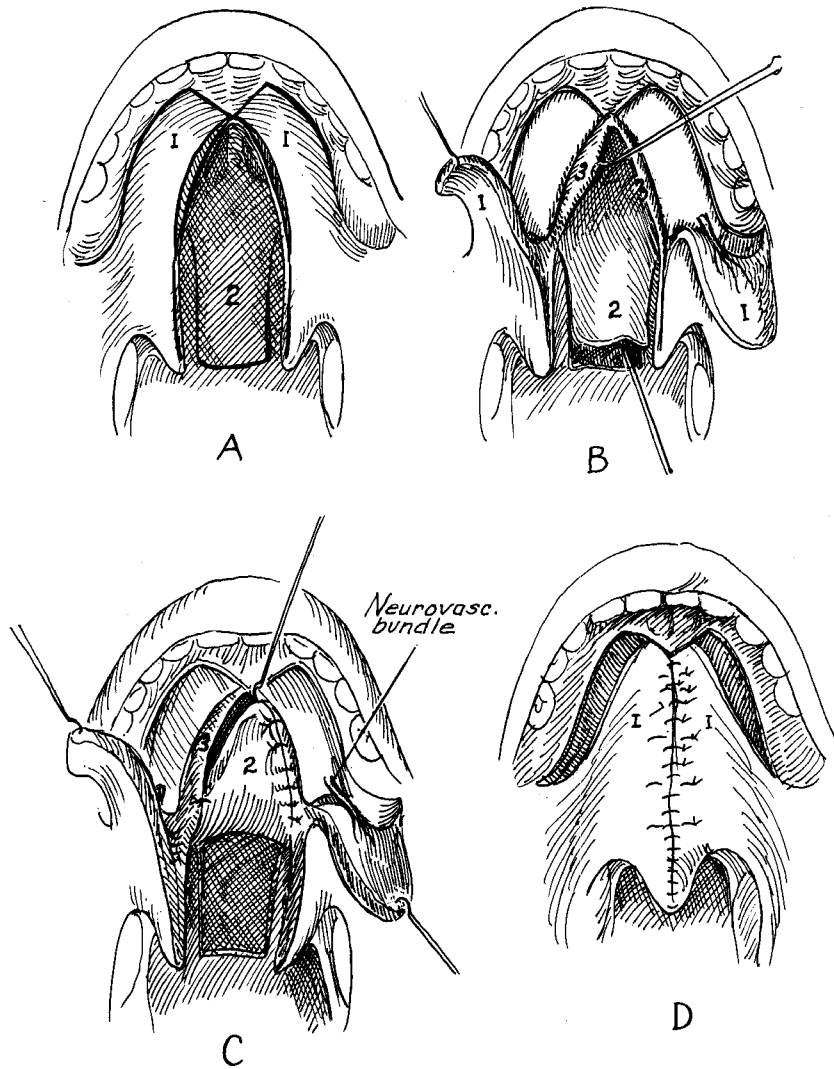

FIGURE 12. Superiorly-based pharyngeal flap combined with primary uranostaphylorraphy (after Nylen, 1961).

- A. Outline of incisions of palatal (1) and pharyngeal flaps (2).
- B. The palatal flaps (1), the pharyngeal flap (2) and flaps on the nasal surface of the palatal shelves (3) are raised.
- C. Suture of the pharyngeal flap (2) to the nasal surface flaps (3).
- D. Position of the palatal flaps (1) at the completion of the operation. The pharyngeal defect has been closed by direct approximation of the edges.

surgical technique for the improvement of inadequate speech due to inadequate velopharyngeal closures and its use and applications have been reviewed by Rees (1964).

The pharyngeal flap has been employed for the following purposes:

- 1) to assure posterior fixation of the soft palate,
- 2) to add functional muscle tissue into the scarred and immobile soft palate; it has also been employed to repair perforations of the soft palate.

The pharyngeal flap operation has been employed as a primary procedure to assist in maintaining adequate length of the repaired palate through posterior fixation and to bring added tissue in a palate with a very wide cleft, particularly in a cleft palate repaired in a later age group.

In addition to providing pharyngeal fixation and adding muscle tissue to the velum, pharyngeal flap operations result in a narrowing of the pharynx as a result of the approximation in the midline of the edges of the donor area of the pharyngeal flap. This pharyngoplasty is thought by many surgeons to be an important added factor in the speech improvement observed following the pharyngeal flap operation.

Passavant (1862) attempted to suture the posterior portion of the velum to the pharyngeal wall. This method was employed in a modified form by Trauner (1951, 1953, 1954). Schönborn (1876) raised a flap from the posterior pharyngeal wall and sutured it into the cleft of the soft palate after freshening the edges of the cleft; the pharyngeal flap was inferiorly based. Rosenthal (1924) popularized the technique of the pharyngeal flap operation. In 1928, Rosenthal wrote "Some time in spite of a long palate, the speech is still bad and some time even when the palate is short, the speech is good." Rosenthal's operation was introduced in the United States by Padgett (1930) and in 1936 Padgett reported on improvement of speech obtained in 68 patients in whom he had performed a pharyngeal flap operation. In 1934, Sanvenero-Rosselli described the superiorly based pharyngeal flap. The pharyngeal flap operation was employed by Marino (1947), Conway (1951), Moran (1951) who employed a superiorly based flap, Dunn (1951), Conway and Stark (1957), and Webster, Quigle, Coffey, Querze, and Russell (1958).

The pharyngeal flap operation has been employed also in combination with palatoplasty as a primary operation in infants. Rosenthal had reserved the use of the pharyngeal flap as a primary type of operation for infants with excessively short palates. The use of the pharyngeal flap as a primary procedure has been described by Burian (1954), Webster and his associates (1958), and Stark and DeHaan (1960). This operation has not been widely accepted in conjunction with a primary palatoplasty in infants because of the possibility of interference with the Eustachian tube function (Ivy, 1960). It has the added inconvenience that if the adenoids must be removed, the flap must be severed prior to adenoidectomy. Most authors feel that the pharyngeal operation should be reserved as a secondary procedure. Undoubtedly, longitudinal studies will eventually demonstrate whether the primary velopharyngoplasty can provide better speech results when it is done in conjunction with uranostaphyloraphy. Velopharyngoplasty would appear to be indicated in patients undergoing surgical closure of the cleft palate in a later age group.

and in patients with a wide cleft, a short palate, and in submucous clefts undiagnosed in infancy.

The use of the pharyngeal flap operation as a means of remedying velopharyngeal incompetence appears to have been satisfactory in a high percentage of cases. The result in 123 patients with velopharyngeal incompetence was reported by Smith, Huffman, Lierle, Moll (1963). They found that the operation achieved competent velopharyngeal closure in 80 to 85% of their patients, a percentage similar to those reported by other investigators. These findings apparently bear little relationship to the etiology of the incompetent mechanism. While the intelligent patient may achieve a superior speech result, an adequate velopharyngeal closure is obtained usually even in children with lower intelligence. These authors also point out that less successful results are obtained on patients operated upon after 15 years of age. They also made an important observation: velopharyngeal closure was not achieved when flaps were too narrow.

Rethi (1932) described the use of two superiorly based pharyngeal flaps taken from each lateral pharyngeal wall and applied to the posterior and nasal margin of the soft palate. This technique was modified by Moore in 1960 and also employed by Sullivan in 1961. The merits of the method are said to be that the use of lateral flaps partially obliterates the large recess of the nasopharynx and the soft palate muscle mass is also augmented by the addition of a flap from either side.

Johansson (1958, 1962) has employed a very large superiorly based pharyngeal flap to close large palatal defects.

Both inferiorly and superiorly based pharyngeal flaps have been employed. Theoretically, the superiorly based flap has certain advantages; it can more easily bridge the gap between the pharynx and the palate; during healing the pedicle is protected from crushing and trauma during the act of swallowing; postoperative hemorrhage is more easily controlled because of better accessibility; the palatal elevation during speech is not interfered with by a possible check rein effect in a caudal direction by an inferiorly based pedicle.

Technique of the Pharyngeal Flap Operation

As previously stated the pharyngeal flap operation may be done in conjunction with primary uranostaphylorrhaphy (Figure 12). The pharyngeal flap operation is usually done in connection with a secondary repair or an elongation procedure of the palate. The soft palate is split in the midline in a preliminary operative step in order to provide adequate retraction and permit direct inspection of the nasopharynx.

An outline of the proposed pharyngeal flap is made with a superiorly or inferiorly based pedicle. As previously stated, a large size flap is desirable. A solution of 1% novocaine with 1:100,000 of epinephrine is infiltrated deep to the musculature of the pharynx, immediately anterior to the prevertebral fascia. This procedure assists in the separation of the flap and in diminishing the amount of bleeding occurring during the operation. Incisions outline the

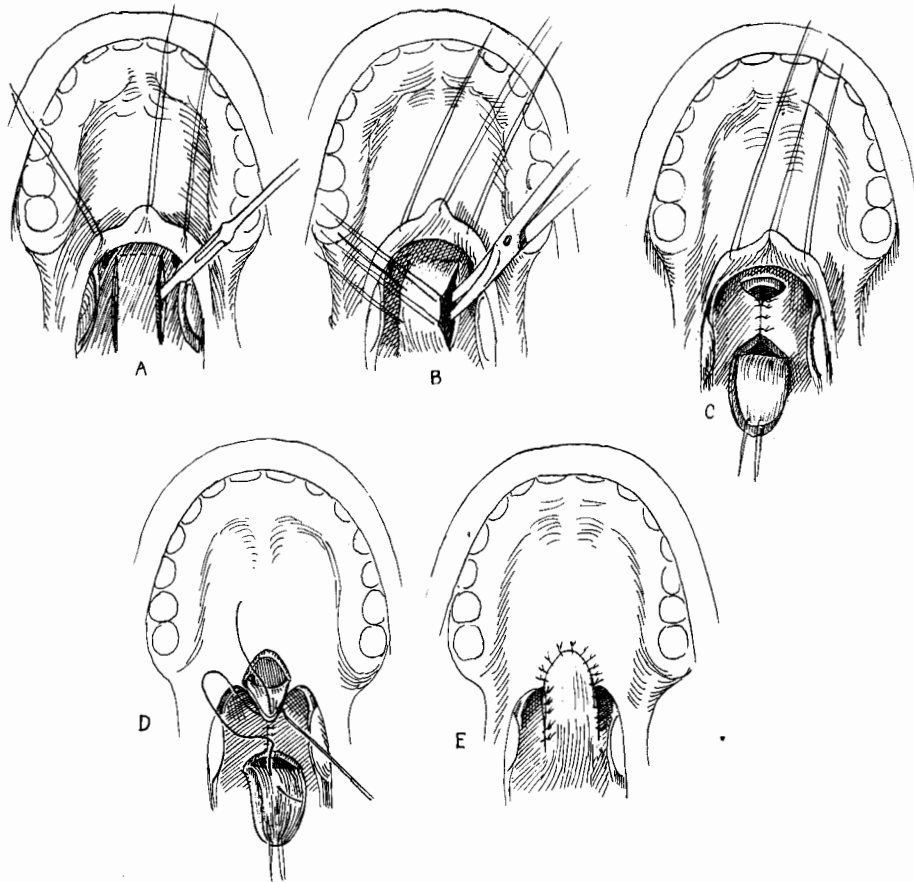

FIGURE 13. Inferiorly based pharyngeal flap for pharyngeal fixation of the soft palate.
 A. Outline incisions of the pharyngeal flap.
 B. The mucomuscular flap is dissected from the prevertebral fascia.
 C. Closure of the donor area of the flap.
 D. The trap door flap is raised from the soft palate and the first suture is placed in order to approximate and appose the flaps.
 E. Operation completed.

flap, the incisions being made through the soft tissues to the prevertebral fascia, and the flap is raised from the fascia by means of curved scissors, care being taken to include all of the muscle tissue. The edges of the pharyngeal wound are then approximated with 4-0 chromic catgut sutures after careful undermining of the edges with scissors.

Veau-Wardill incisions are then made in the palate, the mucoperiosteal flap raised, and the posterior wall of the greater palatine foramen removed; the base of the hamular process may be sectioned at this time if desired.

The flap is then sutured into the median defect of the soft palate. The superiorly based flap is gently manipulated with skin hooks and the tip of the flap suture to the palate in the vicinity of the posterior border of the hard

palate. The edge of the mucous membrane of the flap is sutured to the edge of the mucous membrane on the nasal surface of the soft palate. A few catgut sutures are placed to approximate the muscle tissue of the pharyngeal flap with the adjacent muscle of the soft palate and the mucous membrane on the oral side of the palate is sutured. Alternatively, the flap may be twisted through 180° so that the mucosal surface faces the oral cavity, but this would appear to offer little advantage in most instances.

When pharyngeal fixation is planned without other procedures on the soft palate, a trap door flap of mucous membrane is prepared on the oral surface of the soft palate if an inferiorly based pharyngeal flap is to be used (Figure 13); when a superiorly based pharyngeal flap is planned, the trap door flap should be made on the nasal surface of the soft palate.

The most serious complication following the pharyngeal flap operation is respiratory obstruction during the first 24 to 48 hours following surgery. It is advisable to maintain the patient in a moist atmosphere in a croup tent following the operation. Tracheotomy should be done at the first signs of respiratory obstruction. Walden, Rubin, and Diecidue (1953) advocated the establishment of a preliminary tracheotomy, but this view is not shared by the majority of surgeons. The chances of respiratory obstruction are greater when the operation is done within the first three years and the services of a competent anesthesiologist are imperative to prevent laryngeal edema resulting from the intratracheal intubation.

Pharyngoplasty

The term pharyngoplasty has been employed to designate a surgical procedure aimed at reducing the size of the pharynx both in the antero-posterior and lateral dimensions. Rutenberg (1876) and Wardill (1927) attempted to reduce these dimensions in the pharynx by incising the posterior pharyngeal wall horizontally and suturing it vertically. Browne (1935) advocated a technique consisting of looping a suture from the soft palate around the lateral and posterior walls of the pharynx. In 1950, Hynes described a pharyngoplasty consisting of muscle transplantation by means of which a bulge high on the posterior pharyngeal wall could be produced; by this technique, a dynamic muscle bulge was established rather than a static one (Figure 14). In 1953, Hynes summarized his experiences with this technique which he reserved for two patients in whom acceptable speech had not been obtained by cleft palate surgery. In 1955, Hynes described the use of pharyngoplasty in combination with primary closure of the cleft palate by the Veau-Wardill type of operation. He stresses that the necessary prerequisite for pharyngoplasty is an active and mobile soft palate which actively elevates during phonation. As a result of muscle transplantation pharyngoplasty, Hynes feels that the quality of the spoken vowels is improved by the elimination of lower overtones, the accentuation of upper overtones, and the elevation of the pitch of the voice.

The activity and elevation of the soft palate is determined by cephalometry

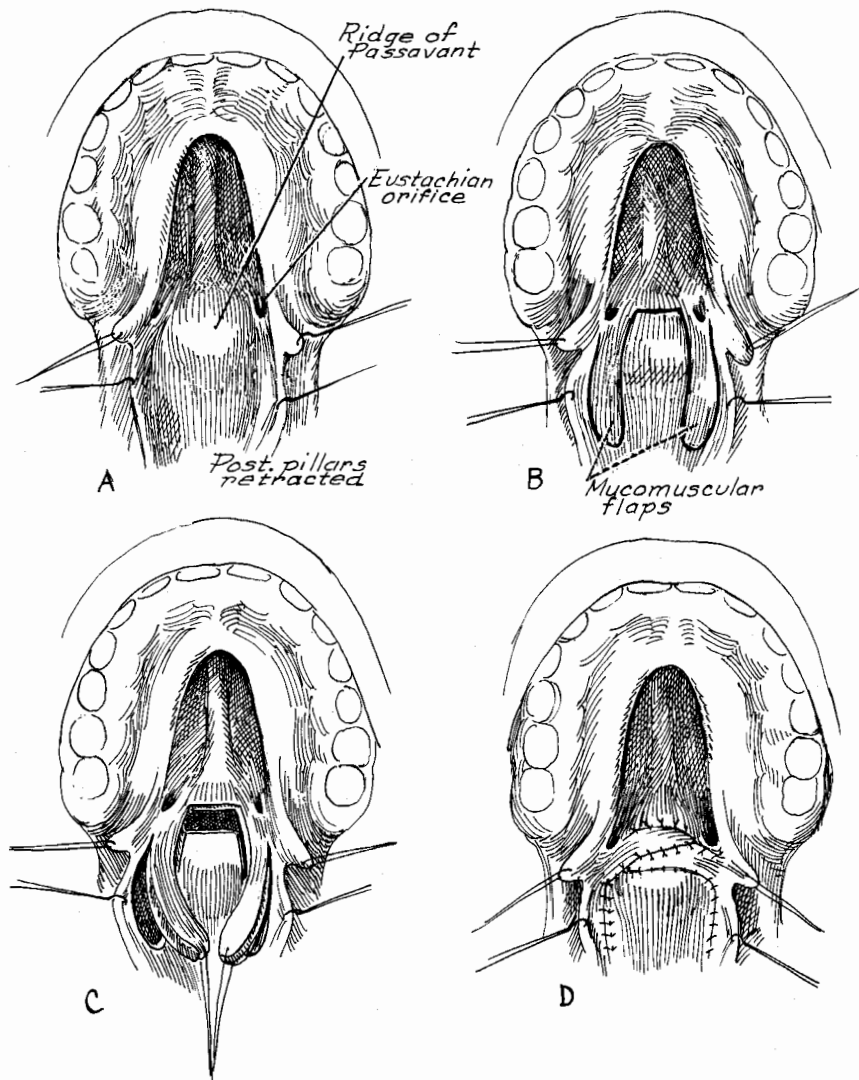

FIGURE 14. Muscle transplantation pharyngoplasty (after Hynes, 1950).

A. Drawing showing relationships of Passavant's ridge and the Eustachian tube opening.

B. Outline of mucomuscular flaps.

C. The flaps are raised; a transverse horizontal incision has been made.

D. Flaps after transposition.

or cinefluoroscopy. The soft palate should elevate to within 0.5 cm of the posterior pharyngeal wall at a level above the arch of the atlas. Muscle transplantation pharyngoplasty would appear to be particularly indicated when the pharynx and nasopharynx are oversized. This should be determined by careful cephalometry and, when possible, frontal plane tomography.

Technique of Pharyngoplasty: A muco-muscular flap is outlined on each side

on the lateral pharyngeal wall (Figures 14A and B). The upper portion of the flap extends directly below the opening of the Eustachian tube. The length of the flap should represent approximately the width of the pharynx. The incisions outlining the flap should extend through the mucous membrane and muscle and each flap comprise the subjacent lateral pharyngeal muscles: the salpingo-pharyngeus, the palatopharyngeus, and fibers of the deeper portion of the superior constrictor muscle. A horizontal incision is then made across the pharynx joining the donor areas of the two lateral flaps (Figure 14 C). The two lateral flaps are transposed into the horizontal incision with their deep muscle surfaces in juxtaposition (Figure 14 D). The muscle flaps are sutured to each other and to the adjacent mucous membrane. The donor areas situated on each side of the pharynx are closed by direct approximation after undermining the pharyngeal mucous membrane on each side.

Pharyngeal Implantation

Passavant's attempts to increase a forward projection of the ridge by means of a flap of tissue folded on itself was followed by attempts by Gersuny in 1900 and Eckstein in 1902 to implant paraffin in the retropharyngeal space. Von Gaza introduced autogenous fatfascia grafts into the retropharyngeal space. Perthes (1912) and Hagerty and Hill (1961) placed autogenous or homologous cartilage grafts into the pharyngeal space by both the transcervical and intra-oral approaches. Blocksma (1963) and others are investigating the implantation of silicone compounds as retro-pharyngeal implants and good results have been reported in an appreciable percentage of cases in obtaining forward projection of the posterior pharyngeal wall by this method and improving speech.

CONCLUSIONS

The main objective of cleft palate surgery, as one of the outstanding workers in the field of palate surgery has stressed (Veau, 1931), is not so much to close the cleft in the palate as to improve speech. Another surgeon, Kilner (1938), who has contributed much to the technique of cleft palate surgery, stated, "There are three aims of such treatment: to make the patient speak well, eat well, and look well, in that order of importance". Many different techniques have been developed to insure the closure of the cleft and restore the function of the muscles of the soft palate and pharynx. But the fact remains that the quality of speech is not always related to the physical findings, some patients having greater ability to utilize their musculature than others; the additional fact that occasionally a mobile soft palate appears to lose its mobility following surgery suggests that the operation performed had a nefarious effect (Spriestersbach, 1963). Undoubtedly, continued studies will lead to a more specific classification of the various types of cleft with a more precise indication of the surgical procedure in each type of problem.

The surgical techniques are now available. The indications and contra-indications for surgery, the age at which the operation should be performed, the type of operation, and the order in which the various rehabilitative measures

should be undertaken: these are the problems which face the cleft palate rehabilitation team (Converse, 1964).

SUMMARY

The development of surgical techniques leading to modern day methods in cleft palate surgery is reviewed. The techniques for primary and secondary procedures including palatal lengthening, pharyngeal flap, pharyngoplasty and pharyngeal implantation are described.

REFERENCES

- AZZOLINI, A., Il septum nasi e il cavo rino-faringeo nella palatoschisi. *Minerva Chir.*, **10**, 972 (1955).
- BACKDAHL, M., & NORDIN, D. E., Replacement of the maxillary bone defect in cleft palate. *Acta chir. Scand.*, **122**, 13 (1961).
- BILLROTH, T., Ueber staphyloraphien bei kindern, Chirurgische Reminiscenzen aus dem Sommersemester. *Wien. med. Wchnschr.*, **21**, 917, (1871).
- BLOCKSMAN, R., Correction of velopharyngeal insufficiency by silastic pharyngeal implant. *Plast. & Reconstr. Surg.*, **31**, 268 (1963).
- BRAUER, R. O., CRONIN, T. D., and REAVES, E. L., Early maxillary orthopedics, orthodontia and alveolar bone grafting in complete clefts of the palate. *Plast. & Reconstr. Surg.*, **29**, 625 (1962).
- BRAUER, R. O., CRONIN, T. D., and REAVES, E. L., Maxillary orthopedics and bone grafting in the cleft palate patient. In: Converse, J. M., *Reconstructive Plastic Surgery*, Philadelphia: W. B. Saunders, Co. (1964).
- BROADBENT, T. R. and HOCHSTRASSE, A. E., Section of the neurovascular bundle: its effect on palatal bulk. *Plast. & Reconstr. Surg.*, **23**, 607 (1959).
- BROADBENT, T. R., and SWINYARD, C. A., The dynamic pharyngeal flap. *Plast. Surg.*, **23**, 301 (1959).
- BROPHY, T. W., *Oral surgery; a treatise on the disease, injuries, and malformations of the mouth and associated parts*. Philadelphia: P. Blakiston's Sons & Co., 563 (1915).
- BROWNE, D., An orthopaedic operation for cleft palate. *Brit. Med. J.*, **2**, 1093 (1935).
- BROWNE, D., An orthopaedic approach to problems of cleft lip and palate. *Trans. Int. Soc. Plast. Surgeons*, 189 (1957).
- BURIAN, F., *Chirurgie Rozstepu Rtu a Patra*, Praha (1954).
- CALNAN, J., Diagnosis, prognosis, and treatment of "palatopharyngeal incompetence," with special reference to radiographic investigations. *Brit. J. Plast. Surg.*, **8**, 265 (1956).
- CALNAN, J., Modern view on Passavant's ridge. *Brit. J. Plast. Surg.*, **10**, 89 (1957).
- CALNAN, J. S., Movements of the soft palate. *Brit. J. Plast. Surg.*, **5**, 286 (1953).
- CALNAN, J. S., The surgical treatment of nasal speech disorders. *Ann. Roy. Coll. Surg.*, **25**, 119 (1959).
- CONVERSE, J. M., Cleft lip and palate: introduction. In *Reconstructive Plastic Surgery*, Philadelphia: W. B. Saunders Co. (1964).
- CONWAY, H., Combined use of the push-back and pharyngeal flap procedures in the management of complicated cases of cleft palate. *Plast. & Reconstr. Surg.*, **7**, 214 (1951).
- CONWAY, H., and GOULIAN, D., Experiences with the pharyngeal flap in cleft palate surgery. *Plast. & Reconstr. Surg.*, **26**, 590 (1960).
- CONWAY, H., and STARK, R. B., Inferiorly based pharyngeal flap in the speech rehabilitation of complicated cleft palate cases. *Trans. Int. Soc. Plast. Surg.*, Baltimore: William & Wilkins Co., 196 (1957).
- CRONIN, T. D., Method of preventing raw area on nasal surface of soft palate in push-back surgery. *Plast. & Reconstr. Surg.*, **20**, 474 (1957).
- DAVIS, W. B., Harelip and cleft palate. *Ann. Surg.*, **87**, 536 (1928).
- DIEFFENBACH, J. F., *Die Operative Chirurgie*. I, Leipzig, F. A. Brockhaus (1845).
- DORRANCE, G. M., Lengthening the soft palate in cleft palate operations. *Ann. Surg.*, **82**, 208 (1925).
- DORRANCE, G. M., Congenital insufficiency of the palate. *Arch. Surg.*, **21**, 185 (1930).
- DORRANCE, G. M., *The Operative Story of Cleft Palate*, Philadelphia: W. B. Saunders Co. (1933).

- DORRANCE, G. M., and BRANSFIELD, J. W., Push-back operation for repair of cleft palate. *Plast. & Reconstr. Surg.*, 1, 145 (1946).
- DUNN, F. S., Observations on the pharyngeal flap operation for the improvement of speech in cleft palate patients. *Plast. & Reconstr. Surg.*, 7, 530 (1951).
- ECKSTEIN, H., Ueber subcutane und submucöse Hartparaffinporthesen. *Deutsch. Med. Wschr.*, 28, 573 (1902).
- FERGUSON, W., Observations on cleft palate and on staphylophary. *Med. Times and Gaz.*, 2, 256 (1944).
- GERSUNY, R., Ueber eine subcutane Prothese Ztschr. f. Heilk., 21, 199 (1900).
- GILLIES, H. G., and FRY, W. K., A new principle in the surgical treatment of "congenital cleft palate" and its mechanical counterpart. *Brit. Med. J.*, 1, 335 (1921).
- VON GRAEFE, C. F., Hufeland u. Harless. *J. pract. Heilk.*, 44, 116 (1817).
- HAGERTY, R. F., and HILL, M. J., Cartilage pharyngoplasty in cleft palate patients. *Surg., Gynec & Obst.*, 112, 350 (1961).
- HAGERTY, R. F., and HOFFMEISTER, F. S., Velopharyngeal closure; an index of speech. *Plast. & Reconstr. Surg.*, 13, 290 (1954).
- HYNES, W., Pharyngoplasty by muscle transportation. *Brit. J. Plast. Surg.*, 3, 128 (1950).
- HYNES, W., The results of pharyngoplasty by muscle transplantation in "failed cleft palate" cases, with special reference to the influence of the pharynx on voice production. *Ann. Roy. Coll. Surgeons*, 13, 17 (1953).
- HYNES, W., The primary repair of clefts of the palate. *Brit. J. Plast. Surg.*, 7, 242 (1955).
- HYSLOP, V. B., and WYNN, S. K., Bone flap technique in cleft palate surgery. *Plast. & Reconstr. Surg.*, 9, 97 (1952).
- IVY, R. H., Some thoughts on postpharyngeal flap surgery in the treatment of cleft palate (an editorial). *Plast. & Reconstr. Surg.*, 26, 416 (1960).
- JOHANSSON, B., Personal communication (1962).
- JOHANSSON, B., and OHLSSON, A., Bone grafting and dental orthopaedics in primary and secondary cases of cleft lip and palate. *Acta chir. scand.* 122, 112 (1961).
- KILNER, T. P., The management of the patient with cleft lip and/or palate. *Amer. J. Surg.*, 2, 204 (1938).
- LANGENBECK, B., Operation der angeborenen totalen Spaltung des harten Gaumes nach einer neuen Methode. *Deutsche Klinik*, 13, 207 (1861).
- LE MONNIER, E., quoted by von Langenbeck, B. Operationen der angeborenen totalen Spaltung des harten Gaumes nach einer neuen Methode. *Deutsche Klinik* 13, 231 (1861).
- LI, C., and LUNDERVOLD, A., Electromyographic study of cleft palate. *Plast. & Reconstr. Surg.*, 21, 427 (1958).
- LIMBERG, A. A., Neue Wege in der radikalen Uranoplastik bei angeboren Spaltendeformationen: Osteotomia interlaminaris und pterygomaxillaris, resectio marginis foraminis palatini und neue Plattchennaht, Fissura ossea occulta und ihre Behandlung. *Zentralbl. f. Chir.*, 54, 1745 (1927).
- LISTON, R., Congenital deficiencies and deformities. *Practical Surgery*, J. Churchill & H. Renshaw, 4th ed. 571 (1846).
- LONGACRE, J. J., DE STEFANO, G. A., DAVIDSON, D. A., and HOLMSTRAND, K., The role of the posterior pharyngeal flap in the rehabilitation of the cleft palate cripple. *Cleft Palate Bull.*, 10, 4 (1960).
- MARINO, H., Cirurgia de la fisura palatina. *Prensa med. Argent.*, 34 2282 (1947).
- MARINO, H., and SEGRE, R., Cleft palate; pharyngo-staphyline fixation. *Brit. J. Plast. Surg.*, 3 222 (1951).
- MOORE, F. T., A new operation to cure nasopharyngeal incompetence. *Brit. J. Surg.*, 47, 424 (1960).
- MORAN, R. F., The Pharyngeal flap operation as a speech aid. *Plast. & Reconstr. Surg.*, 7, 202 (1951).
- NORDIN, K. E., and JOHANSSON, B., Freie Knochentransplantation bei Defekten im Alveolarkamm nach Kieferorthopädischer Einstellung der Maxilla bei Lippin-Kiefer-Gaumen-spalten. *Fortchr. Kiefer Gesichtschir.* 1, 168 (1955).
- NYLEN, B. O., Cleft Palate and Speech *Acta Radiologica*, Supp. 203. Stockholm (1961).
- PADGETT, E. C., The repair of cleft palate after unsuccessful operations with special reference to cases with an extensive loss of palate tissue. *Arch. Surg.*, 20, 453 (1930).

- PADGETT, E. C., Repair of cleft palate after unsuccessful operation. *Surg., Gynec. & Obst.*, **4**, 63 (1936).
- PASSAVANT, G., Über die Operation der angeborenen Spalten des harten Gaumens und der damit complicirten Hasenschichten. *Arch. Heilk.*, **3**, 193 (1862).
- PASSAVANT, G., Ueber die Beseitigung der naeselden Sprache bei angeborenen Spalten des harten und weichen Gaumens (Gaumensegel, Schlundnaht und Ruecklagerung des Gaumensegels), *Arch. f. klin. Chir.*, **6**, 333 (1865).
- PEER, L. A., Cleft palate deformity and the bone flap method of repair. *Surg. Clin. N. A.*, **39**, 313 (1959).
- PERTHES, H., Beitrag zur Behandlung von Gaumenspalten. Diss. Tubingen: (1912). (Quoted by Nylen, B. O. 1961).
- PRUZANSKY, S., Description, classification, and analysis of unoperated clefts of the lip and palate. *Amer. J. Orthodont.*, **39**, 590 (1953).
- REES, T. D., Operations for the correction of palatopharyngeal incompetence. In: Converse, J. M., *Reconstructive Plastic Surgery*, Philadelphia: W. B. Saunders Co. (1964).
- REIDY, J. P., Cleft lips and palates: survey of 370 cases. *Brit. J. Plast. Surg.*, **12** 215 (1959).
- RETHI, A., Operative Rachenverengerung, zur Behebung der Rhinolalia aperta. *Monatschr. f. Ohrenh.*, **66**, 842 (1932).
- RICKETTS, R. M., The cranial base and soft structures in cleft palate speech and breathing. *Plast. & Reconstr. Surg.*, **14**, 47 (1954).
- ROSENTHAL, W., Zur Frage der Gaumenplastik. *Zbl. Chir.*, **51**, 1621 (1924).
- ROUX, J., Observation sur une division congénitale du voile du palais et de la luette, guérie au moyen d'une opération analogue à celle du bec-de-lièvre, pratiquée par M. Roux. *Jour. universel des Sci. Med.*, **15**, 356 (1819).
- RUTENBERG, D. C., Ueber Gaumenspaltennaht und Erzielung einer reinen (nicht naeseldn) Sprache durch Vorlagerung der hinteren Schlundwand. *Wien. med. Wchnschr.*, **26**, 815 (1876).
- SANVENERO-ROSSELLI, G. L., La divisione congenita del labbro e del palato. Casa Editrice Luigi Pozzi, Roma (1934).
- SCHMID, E., Die Annäherung der Kieferstumpfe bei Lippen-Kiefer-Gaumenspalten; ihre Schädlichen Folgen und Vermeidung. *Fortschr. der Kiefer Gesichtschir.*, **1**, 168 (1955).
- SCHONBORN, G., Ueber eine neue Methode der Staphylorrhapie. *Arch. Klin. Chir.*, **19**, 527 (1876).
- SCHRUDDE, J., and STELLMACH, R., Primäre Osteoplastik und Kieferbogenformung bei Lippen-Kiefer-Gaumenspalten. *Fortschr. Kiefer Gesichtschir.*, **5**, 247 (1959).
- SMITH, J. K., HUFFMAN, W. C., LIERLE, D. M., and MOLL, K. L., Results of pharyngeal flap surgery in patients with velopharyngeal incompetence. *Plast. & Reconstr. Surg.*, **32**, 493 (1963).
- SPRIESTERSBACH, D. C., Personal communication (1963).
- STARK, R. B., and DEHAAN, C. R., The addition of a pharyngeal flap to primary palatoplasty. *Plast. & Reconstr. Surg.*, **26**, 378 (1960).
- SUBTELNY, J. D., Width of the nasopharynx and related anatomic structures in normal and unoperated cleft palate children. *Amer. J. Orthodontics.*, **41**, 889 (1955).
- SUBTELNY, J. D., and KOEPP-BAKER, H., The significance of adenoid tissue in velopharyngeal function. *Plast. & Reconstr. Surg.*, **17**, 235 (1956).
- SULLIVAN, D. E., Bilateral pharyngoplasty as an aid to velopharyngeal closure. *Plast. & Reconstr. Surg.*, **27**, 31 (1961).
- TRAUNER, R., Ergebnisse der Gaumenspalten- und Lippenspaltenoperationen. *Z. Stomatol.*, **48**, 412 (1951).
- TRAUNER, R., Über eine neue Methode der Velo-Pharynxplastik bei zu kurzem weichem Gaumen. *Langenbeck's Arch. Klin. Chir.*, **274**, 204 (1953).
- TRAUNER, R., Die Chirurgie als Helferin der Sprach- und Kaufunktion. *Med. Klin.*, **49**, 616 (1954).
- VEAU, V., *Division Palatine*. Paris: Masson & Cie (1931).
- VEAU, V., Les résultats anatomiques et fonctionnels de la staphylorrhapie par les procédés classiques. *Rev. de Chirurgie.*, **2**, 81 (1922).
- VEAU, V., BOREL-MAISONAY, F., and MISSET, D., Die funktionellen Ergebnisse der Gaumenplastiken, die sich bei der Röntgendurchleuchtung darstellen. Festschrift für Prof. Hans Pichler, *Wiener Zeitschrift für Stomatologie*, Heft 9, 35. Jahrgang (1937).

- VEAU, V., and BOREL-MAISONNAY, S., Radioscopie et staphylorrhapie. *Mem. Acad. chir.*, **69**, 3 (1943).
- WALDEN, R. H., RUBIN, L. R., and DIECIDUE, A. A., A technical aid in the pharyngeal flap operation. *Plast. & Reconstr. Surg.*, **12**, 198 (1953).
- WARDILL, W.E.M., Discussion of the treatment of cleft palate by operation. *Proc. Roy. Soc. Med.*, **5**, 178 (1927).
- WARDILL, W.E.M., The technique of operation for cleft palate. *Brit. J. Surg.*, **25**, 117 (1937).
- WARREN, J. C., On an operation for the cure of natural fissure of the soft palate. *Am. J. Med. Sc.*, **3**, 1 (1828).
- WEBSTER, R. C., QUIGLEY, L. F., COFFEY, R. J., QUERZE, R. H., and RUSSELL, J. A., Pharyngeal flap staphylorrhaphy and speech aid as a means of avoiding maxillofacial growth abnormalities in patients with cleft palate. *Am. J. Surg.*, **96**, 820, (1958).

AUDIOLOGICAL PROBLEMS ASSOCIATED WITH CLEFT PALATE

CLAUDE S. HAYES

University of Wisconsin, Madison, Wisconsin

Recently, some attention has been given to hearing problems associated with cleft palate. There is little agreement among the findings of the studies. However, most investigators would agree with the following three statements:

1. Hearing loss occurs more frequently in the cleft palate population than in the noncleft palate population. (Drettner, 1960; Gaines, 1940; Gannon, 1950; Halfond and Ballenger, 1956; Sataloff and Fraser, 1952; Holmes and Reed, 1955, Means and Irwin, 1954; Miller, 1956; and Wagner, 1941);
2. Such hearing losses are almost always conductive in type. (Drettner, 1960; Halfond and Ballenger, 1956; Miller, 1959; and Skolnik, 1958);
3. The majority of such hearing losses are bilateral. (Drettner, 1960; Halfond and Ballenger, 1956; Miller, 1959; and Skolnik, 1958.)

The disagreements among the findings of various investigators can be partially explained by the following facts:

The cleft palate population has been treated as a single clinical entity. Only recently have experimenters differentiated among variables such as: the age of the child at time of testing, the type of cleft, the type of physical management, the age of the child at the time of surgery, and the presence of associated anomalies. (Skolnik, 1958; Spriestersbach, 1958.) In previous studies individuals with a cleft of the palate were treated as a homogeneous group. No consideration was given to the possibility that hearing loss may be related to the above variables within the cleft palate population.

A second factor that helps to explain disagreements among the results of the studies is that each investigator has defined "hearing loss" in his own way. Here are several definitions of hearing loss which have served as a basis for studies:

1. A loss in two frequencies between 250 and 8 000 cps. (Halfond and Ballenger, 1956);
2. A loss for one frequency between 500 and 2 000 cps;
3. An average loss for the three speech frequencies of 500, 1 000 and 2 000 cps. (Graham, 1962; Holmes and Reed, 1955; Spriestersbach and others, 1962);
4. An average loss for six frequencies tested between 250 and 8 000 cps. (Spriestersbach and others, 1962);
5. A loss at any one of six frequencies tested between 250 and 8 000 cps. (Spriestersbach and others, 1962);
6. A loss at 8 000 or 12 000 cps. (Miller, 1956), and finally;

7. A "recognizable handicap of hearing" without any stated method of determining the handicap (Berry and Eisenson, 1956).

Compounding this state of confusion, these investigators selected different decibel levels ranging from 5 to 30 dB as constituting a hearing loss. This selection of different decibel levels, as well as the variation in frequencies used in the determination of a hearing loss, makes it extremely difficult to compare data in the studies. It is little wonder, then, that we find the incidence of hearing loss associated with cleft palate stated as ranging from 3% to 90% (Spriestersbach, 1958).

Spriestersbach and his colleagues demonstrated in a recent article that for the same population the incidence of hearing loss could range from 3% to 74%, merely by evaluating data in different ways. They used three of the definitions of hearing loss listed above and applied three different decibel levels—10, 20, and 30 dB—to these definitions. It seems obvious that if the comparison of the results of one study to the results of another study is to be valid, what constitutes a hearing loss must be determined.

Unfortunately, there is little agreement among audiologists concerning both the decibel level and the frequencies that should be included in a formula for determining the significance of a hearing loss. First, it must be decided whether medically significant or educationally significant hearing losses are being identified, for they are not the same. I would like to propose two definitions: that a medically significant loss be one which shows a deviation of 15 dB, reference average normal zero, at two frequencies between 250 and 8000 cps, if the purposes of the testing are to identify incipient hearing loss and, to prevent, through medical treatment, further loss from developing; and, that educationally significant hearing loss be one which shows an average loss of 20 dB, reference average normal zero, in the speech frequencies of 500 to 2000 cps, if the purpose of the testing is to identify hearing loss which would interfere with the child's acquisition of speech, vocabulary, and language and with his educational achievement.

Once a definition as to what constitutes a hearing loss has been agreed upon and a formula has been derived to compute this loss, future research will be more meaningful. It is hoped that future investigators will follow the direction indicated by Skolnik (1958), Spriestersbach (1962), Masters (1960), and their co-workers, for they have suggested that various subgroups of the cleft palate population may differ in the incidence and degree of hearing loss.

At the present time, all possible subgroups within the cleft palate population have not been identified. However, certain variables within this group have been identified, and hearing loss as pertains to these variables has been studied.

One of these variables is the age of the subject when his hearing is tested. Skolnik reports that for cleft palate children there is a gradual increase in middle ear pathology with age. He found that such pathology existed in 6% of cleft palate children under one year of age, in 27% of cleft palate children between 1 and 4 years of age, and in 69% of cleft palate children between 5

and 8 years of age. He also found that “. . . a gradual increase of ear disease exists up to the school age and then persists at a plateau level.” Although hearing thresholds were not reported for these subjects according to their age, it would seem obvious that hearing would vary with the condition of the middle ear.

Glover's findings that cleft palate children between the ages of 2 to 5 years have repeated middle ear infections whether the palate has been repaired or not supports Skolnik's data. Glover further states that at some time between the ages of 2 and 5 years, “hearing loss is likely to be noted,” but that once competent palatal function is acquired, “middle ear infections become less frequent, and hearing improves . . . On the other hand if palate closure is inadequate middle ear infections will continue . . .”

In a study completed in 1962, Spriestersbach, Lierle, Moll and Prather found that “. . . the hearing acuity of children with cleft palates varies as a function of age. Children who were 6 years of age or older when they were tested had significantly smaller incidence and magnitude of loss than did children tested before 6 years of age.” These authors did not believe that this difference was a result of unreliable thresholds obtained in the younger group.

In testing 42 cleft palate adults ranging in age from 16 to 75 years, Goetzinger and colleagues found that “as a group the subjects possess a hearing level which is within the limits of normal hearing.” They further found that auditory discrimination scores for these same subjects were also within normal limits.

From the results of these studies, it would seem safe to conclude that the hearing of a person with a cleft palate varies according to his age at testing.

A second variable within the cleft palate population is the type of cleft. Masters, Bingham, and Robinson report that among 172 children with cleft lips and palates, the highest incidence of hearing loss occurred in wide palatal clefts involving both the soft and hard palates. According to Masters and his co-authors, these Class II clefts are often surgically difficult to handle.

Spriestersbach and his colleagues found that the incidence of hearing loss tended to occur more frequently in children with clefts of the palate only, than in children with clefts of both the lip and palate. However, the differences between the two groups were not statistically significant, either in incidence or degree of hearing loss.

Skolnik reports that in 337 cleft palate subjects incidence of hearing loss is greater in unilateral cleft lip and palate than in cleft of the hard and soft palates. There are no analyses of the data in this study to determine whether these differences are statistically significant.

The data from the above studies do not statistically support the hypothesis that hearing loss is related to the type of cleft. This is an area in which further research is needed.

A third variable within the cleft palate group is physical management. This would include surgery: the age of the child at time of surgery, the type of

surgery, and the number of operations; the prosthesis: the age when the child was fitted with a prosthesis; or, a combination of surgery and prosthesis.

Spiestersbach and co-workers report that children who were between 30 and 48 months of age when their palates were surgically repaired had poorer pure tone thresholds for hearing in both the better and worse ear than did children whether younger (25 months or less) or older (49 months or more) at the time of repair. These researchers qualify their findings by stating that the differences in thresholds "can probably be attributed almost entirely to age differences between the three groups at time of testing."

Masters and his co-authors report the age of palatal repair plays an important role in producing or preventing hearing loss. They state, "If the palatal reconstruction is deferred beyond 18 months of age, the incidence of hearing loss appears to rise almost by arithmetic progression as age increases." They conclude by stating, "If normal hearing is used as one of the end points of palatal rehabilitation, it would appear that early surgical repair of soft tissue variety would be indicated."

It should be pointed out that Masters and his colleagues did not consider the age of the child at the time he was tested. As stated before, the hearing loss of cleft palate children varies according to the age at testing.

Skolnik evaluated the effects of early surgical closure on school-age children. Forty-one of his subjects had palatal closure before one year of age; 48 had palatal closure after two years of age. The percentage of middle ear pathology for the two groups was approximately the same, 73% and 75%, respectively. He refutes the opinion that early closure of the palate avoids secondary atrophy of the palatal muscles and prevents otitis media. He states, "The dangers of early closure in relation to interference with centers of bone growth, and consequent serious disturbances of development of the bones of the jaw and face, and the high incidence of middle ear pathology, factors which are probably directly or indirectly related to each other, questions the validity of surgery at an early age, in many cases."

Very little information is available concerning the effect of the type of surgery upon the incidence of hearing loss. Two studies are noteworthy, although they consider only three of the many possible types of surgery.

Masters and his colleagues compared two surgical techniques. They report a lower incidence of hearing loss when the method of surgical repair is closure with lengthening of the palate than when the method of repair is surgical closure without lengthening.

Graham and Lierle studied the effects of a third type of surgery—the posterior pharyngeal flap palatoplasty on the hearing and otologic condition of 43 cleft palate subjects ages 7 to 26 years. No subject developed a middle ear infection following the pharyngeal flap surgery unless he had previously had such an infection. No subject developed a greater hearing loss following the surgery. Graham and Lierle conclude that posterior pharyngeal flap

palatoplasty has no effect on the otologic condition of the cleft palate patient provided the operation is performed after the child is five years old.

In addition to the type of surgery as a variable within the cleft palate group, the number of operations and the operative results need to be studied in relation to hearing loss. The operative results include such factors as scarring, tightness of the palate, Eustachian tube dysfunction, and the adequacy of the velopharyngeal closure.

The effects on hearing loss of a second type of physical management – the use of obturators – should also be considered. Masters and coauthors report a higher incidence of hearing loss when a cleft is prosthetically repaired than when it is surgically repaired. It is their opinion that this high incidence of hearing loss has two causes. The first is the difficulty in constructing for and maintaining an obturator in a child under two years of age; the second is the failure of a prosthesis to restore the dynamic function of the palatal musculature, primarily the levator and the tensor palatini.

Spiestersbach and his co-workers also found in their study that the incidence of hearing loss was greater in children who had been fitted with obturators than with children who had their clefts surgically repaired. The degree of loss between these two groups was not significantly different. These investigators report a rather startling result in their study: there were no significant differences in the incidence of hearing loss between those subjects whose palates were surgically repaired and those subjects whose palates were unrepaired. This finding has led them to doubt that the high incidence of hearing loss found in subjects wearing obturators can be explained as due to poorly functioning palatal musculature.

Here are two contradictory opinions concerning the relationship of the proper functioning of the levator and tensor palatini muscles and the incidence of hearing loss. An experiment conducted on dogs by Holborow investigated conductive deafness associated with cleft palate. Holborow was interested in evaluating the importance of the tensor palatini muscle in normal function of the Eustachian tube. Direct recordings of the middle ear air pressure were made while he electrically stimulated the pharyngeal muscles of the dogs. Middle ear air pressure recordings made when the tensor palatini tendon was sectioned at the hamulus were different from the air pressure recordings made when the tensor palatini was intact. In Holborow's opinion, failure of the Eustachian tube to function properly was due to the sectioning of the tensor palatini tendon. In applying these findings to humans, the author suggests that hearing impairment in cleft palate children is related to tensor palatini muscle malfunction. Such malfunction may occur as a result of "(1) poor muscle development, (2) absence of firm anchorage for the muscle, and (3) damage to the muscle during surgery including alteration of the angle of pull by fracture of the hamulus, nerve injury, and/or scarring and fibrosis around the muscle."

It is an accepted fact that the use of an obturator interferes with normal functioning of the palatal musculature. Holborow's research with animals

would imply, then, that the incidence of hearing loss with individuals fitted with obturators would be high.

Graham, Schweiger and Olin studied the relationship between the prevalence of middle ear infection and hearing loss both before and after insertion of an obturator. None of the 54 subjects examined developed middle ear infections following the fitting of an obturator unless he had previously had such infections. No subject developed a greater hearing loss following the fitting of an obturator. It should be noted that these subjects received otologic care from infancy and that obturators were not inserted prior to four years of age.

Another aspect of the physical management variable is the combination of surgical and prosthetic closure. An area worthy of investigation is the relationship between this variable and the incidence and degree of hearing loss. There are no known studies in this area.

The last variable to be considered within the cleft palate group is the communication skills of cleft palate children. Worthy of further study is the relationship between this variable of communication skills and the incidence and degree of hearing loss.

Although Brown, Bzoch, and McWilliams have discussed factors that might be related to language development in children with cleft palate, it was Spriestersbach, Darley, and Morris who formally investigated the language status of these children. In a study reported in 1958 they obtained three measures of language development for 40 children with clefts of the palate, ranging in age from three years six months to eight years five months. These language measures were: mean length of response, structural complexity score, and vocabulary size. They reported the following conclusions:

- “(1) Children with cleft palates are in general retarded in mean length of response;
- (2) Their language development as measured by structural complexity scores is not different on the average from that of the normative group;
- (3) They are in general retarded in vocabulary usage.”

In other words, there was no general retardation in language but there was retardation in amount of verbal output and vocabulary usage.

Morris investigated the communication skills of 107 children with cleft lips and palates, ranging in age from two years four months to fifteen years five months. He excluded from his study children with neuromuscular impairment (other than that possibly associated with the clefts) and children with hearing loss which he defined as educationally significant. A child was excluded if he had a 30 dB loss in the better ear in two of the three frequencies: 500, 1 000, and 2 000 cps, or a 20 dB loss in the better ear in more than two frequencies in the speech range.

Morris' assessment of the language of these children included measures of connected speech, vocabulary size, and articulation skills. He concluded, among other things, that “children with cleft lips and palates are significantly

retarded in communication skills," and that "a single measure may [not] be used as an index of general status of language development." Although Morris did exclude children with a specified degree of hearing loss at the time he tested them, it would be impossible for an investigator to know what the hearing of the children had been prior to this time. As has been pointed out, the hearing of children with cleft palates does vary as a function of their age. It would seem logical to conclude that many of the children in Morris' study possessed hearing loss of an undetermined degree at some stage in their development. If we accept this premise, then hearing loss may also be a factor that must be considered when we attempt to explain the retardation in communication skills of the child with a cleft palate.

To summarize, in order to clarify some of the confusion that has developed regarding incidence of hearing loss in the cleft palate population, we, as a professional group, need to determine what is a hearing loss; we need to devise a formula for computing the degree of hearing loss; and, we need to define the effects of hearing loss on speech and language development and educational achievement. It has been pointed out that there may be many subgroups within the cleft palate population. A number of variables which may affect the incidence and degree of hearing loss in this population have been discussed.

The effect of a hearing loss upon a person with a cleft palate cannot be ignored, even though, otologically, the hearing loss may be reversible. If the hearing loss occurs when the child is between two and five years of age—the important speech formative years—a delay in sound, speech, and language development may occur. The speech pathologist needs to be concerned with more than articulation defects and voice disorders. He needs to be concerned with the use of auditory training in correction of sounds as well as the building of vocabulary and facilitating of language growth and development. Masters and his colleagues have stated, "The former goals of cleft palate therapy, in particular normal speech and normal facial growth, must be enlarged to include normal hearing if the rehabilitation program for children with congenital clefts is to be adequate."

To this statement I would like to add that if normal hearing cannot be restored in the cleft palate child, techniques appropriate to a child with a hearing loss should be included in the therapy program.

REFERENCES

- BERRY, M. F. and EISENSON, J., *Speech Disorders: Principles and Practices of Therapy*. New York: Appleton-Century Crofts, Inc. (1956).
- BZUCH, K. R., Six mechanisms of disturbance in cleft palate speech. *Cleft Palate Bulletin*, 11, 2, 26-28 (1961).
- DRETTNER, B. The nasal airway and hearing in patients with cleft palate. *Acta Otolaryng.*, 52, 131 (1960).
- GAINES, F. P., Frequency and effect of hearing losses in cleft palate cases. *JSD*, 5, 141-149 (1940).
- GANNON, J., A study of the effect of certain surgical variables on the auditory acuity of fifty cleft palate children. M.A. Thesis, University of Washington (1950).

- GLOVER, D. M., A long range evaluation of cleft palate repair. *Plastic and Reconstructive Surgery*, 27, 19-30 (1961).
- GOETZINGER, C. P., EMBREY, J. E., BROOKS, R., and PROUD, G. O., Auditory assessment of cleft palate adults. *Acta-Oto-Laryngol.* 52, 551-557 (1960).
- GRAHAM, M., and LIERLE, D., Posterior pharyngeal flap palatoplasty and its relationship to ear disease and hearing loss. *Laryngoscope*, 72, 1750-1755 (1962).
- GRAHAM, M. D., SCHWEIGER, J. W., and OLIN, W. H., Hearing loss and ear disease in cleft palate patients with obturators. *Plastic and Reconstructive Surgery*, 30, 3, 348-358 (1962).
- HALFOND, M. M., and BALLENGER, J. J., An audiologic and otorhinologic study of cleft-lip and cleft-palate cases. I. *AMA Arch. of Otolaryng.*, 64, 58-62 (1956).
- HOLBOROW, C., Conductive deafness associated with cleft palate deformity, *Proc. Royal Soc. Med.*, 55 (1962), pp. 305-307. Abstracted in the *Cleft Palate Bulletin*, 13, 2, (1963).
- HOLMES, E. M., and REED, G. F., Hearing and deafness in cleft palate patients. *AMA Archives of Otolaryngology*, 62, 620-624 (1955).
- JOHNSON, W., BROWN, S. F., CURTIS, J. F., EDNEY, C. W., and KEASTER, J., *Speech Handicapped School Children* (Rev. ed.), New York: Harper, (1956).
- MASTERS, F. W., BINGHAM, H. G., and ROBINSON, D. W., The prevention and treatment of hearing loss in the cleft palate child. *Plastic and Reconstructive Surgery*, 25, 503-509 (1960).
- MCWILLIAMS, BETTY JANE, Some observations of environmental factors in speech development of children with cleft palate. *Cleft Palate Bulletin*, 6, 1, 4-5 (1956).
- MEANS, B. J. and IRWIN, J. V., An analysis of certain measures of intelligence and hearing loss in a sample of Wisconsin cleft palate population. *Cleft Palate Bulletin*, 4, 2, 4 (1954).
- MILLER, M. H., Hearing loss in cleft palate cases: the incidence, type and significance. *Laryngoscope*, 66, 1492-1496 (1956).
- MILLER, M. H., Hearing problems associated with cleft palate. *Annals of Otolology, Rhinology and Laryngology*, 68, No. 1, 90-99 (1959).
- MORRIS, H. L., Communication skills of children with cleft lips and palates. *J. Speech Hearing Res.*, 5, 1, 79-90 (1962).
- SATALOFF, J. and FRASER, M., Hearing loss in children with cleft palates. *AMA Arch. of Otolaryng.*, 55, 61-64 (1952).
- SKOLNIK, E. M., Otologic evaluation in cleft palate patients. *The Laryngoscope*, 68, 11, 1908-1949 (1958).
- SPIESTERSBACH, D. C., DARLEY, F. L., and MORRIS, H. L., Language skills in children with cleft palates. *J. Speech Hearing Res.*, 1, 3, 279-285 (1958).
- SPIESTERSBACH, D. C., LIERLE, D. M., MOLL, K. L., and PRATHER, W. F., Hearing loss in children with cleft palates. *Plastic and Reconstructive Surgery*, 30, 3, 336-347 (1962).
- WAGNER, J. A., A Survey of the hearing and intelligence of fifty cleft palate children. M.A. Thesis, University of Washington (1941).

OTHER CONCOMITANT CONDITIONS: OTHER PHYSICAL CONDITIONS

EDWARD F. LIS

University of Illinois, Center for Handicapped Children, Urbana, Illinois

In the perspective of mass assault and division of labor which characterizes many of our activities concerning children with cleft palate the charge to this panel is noteworthy. It declares our recognition that although we label these children generically, their habilitation involves activity with all of their handicaps, many of which are outside the oral cavity.

The subject of "other physical conditions associated with cleft palate" is endless; it begins with the appreciation that these children, like others with congenital anomalies, often have multiple expressions within them of germ plasm defects; it continues with the realization that every one of these malformations is best expressed as a syndrome combining morphologic and patho-physiologic observations; as growth takes place there is also the experience that secondary handicaps occur with a degree of uniformity in this population.

Frequency of Other Malformations

Statistical studies about other congenital anomalies with cleft palate have been reported with a frequency varying from 10-25% (Fogh-Anderson, 1942; Lutz and Moor, 1955). Our own sample at the Cleft Palate Center of the University of Illinois is of the latter dimension; however, upon it is intruded a bias of selective clinic case load. The impact of other anomalies on this population is also confused by the differences in definition of an anomalous state and undoubtedly by variations in time and thoroughness of examination of the patient. It has been noted, not too unexpectedly, that the incidence estimate of congenital malformations is higher with increasing age of the sample under study; thus malformations have been reported at an incidence level of 1-1.5% from birth period studies and at 3-7.5% in other studies when observations were around one year. Despite the looseness of our data collection on this point, clinical experiences suggest that multiple anomalies are fairly common and need become our concern in relating to cleft palate habilitation.

In the same vein, but related to some of the secondary handicaps in this group, there is confusion about the prevalence of serious dental disease, hearing loss, psycho-social problems, and even mental retardation. Some of the reports in the literature would suggest that the children with cleft palate, as a whole, bear the burden of innumerable complications. Surprisingly enough a large

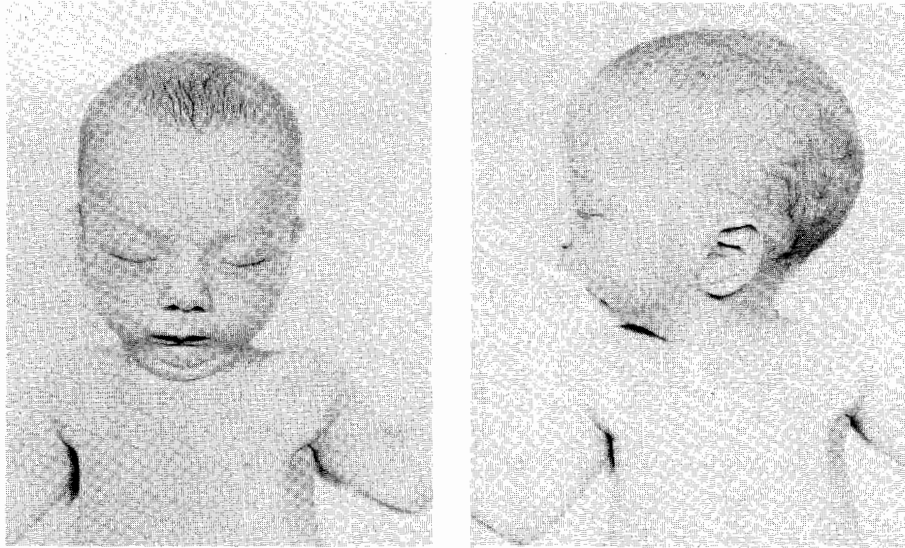

FIGURE 1a. The Pierre Robin Syndrome. Photograph illustrating the micrognathia—a major factor responsible for the respiratory distress in these children.

number of these children are relatively uncomplicated youngsters and go through an orderly habilitation process with good results. Recent publications which have taken into consideration more careful definition of the clinical findings which can be equated with a handicapped state (caries, hearing loss), socio-environmental factors, and family patterns (sibling comparisons) have suggested a smaller prevalence of secondary disabilities specifically related to the influence of cleft palate. Such reports do not necessarily indicate the problems are of lesser magnitude than supposed, but they do recommend an approach more geared to the family and environment than exclusively toward the child. Other speakers will likely make these points more adequately.

Other Physical Conditions

In projecting a panoramic approach to cleft palate children from the medical care standpoint, it is tempting to paraphrase from an omnibus description of normal children, to this effect: Every child with a cleft palate is in certain respects (a) like all other children, and, therefore, can be expected to have the same variety and statistically at least the same incidence of all other handicapping conditions such as cerebral palsy, congenital heart defects, specific perceptual disturbances, etc., (b) however, he is also more like some other children and, therefore, there needs to be a high index of suspicion that he is susceptible to all of the complications known to the cleft palate group, and (c) he is like no other child; therefore, he is able to have his own unique combination of problems and health needs.

Except for specific examples, such is the perspective of the subject of Other Physical Conditions.

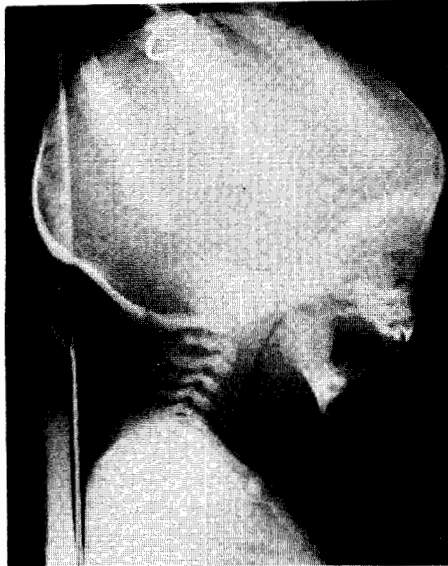

FIGURE 1b. The Pierre Robin Syndrome. Lateral head x-ray of same child illustrating the retropositioning of the tongue with consequent impingement on the hypopharyngeal airway.

To keep the rest of this presentation within bounds, the more frequent or critical associated conditions should be illustrated. A reasonable subdivision would be to concern ourselves first with events about the postnatal period and, second, with those factors which create problems as development progresses.

Postnatal Period

A. Respiratory Problems

In the immediate period after a child's birth, the quality of extra-uterine adjustment is a major concern. It is at this point that some children with isolated cleft palate may encounter a crisis, particularly if the cleft is associated with an underdeveloped jaw, a micrognathia, which almost of necessity intrudes the tongue into the hypopharyngeal airway. This condition, called the Pierre Robin Syndrome, is relatively common in this sub-group although with a variety of manifestations from mild to severe respiratory embarrassment. Although initial treatment is geared to promoting survival, its full measure of adequacy is tested by the absence of any central nervous system complications which might range from subtle neuromotor or sensory defects to cerebral palsy, convulsions, mental retardation or behavior, and learning disorders.

Figure 1 pictures a child with such a syndrome. The small jaw is apparent; what isn't visualized is the acute inspiration effort.

Figure 2 is a lateral x-ray of a similar subject. Note the diminished airway, the presence of a small jaw, and the retroposition of the tongue. Treatment involves careful positioning of the infant in an attempt to diminish the intrusion of the base of the tongue in the airway; in some instances, suturing the tongue to the alveolar ridge and lips may be required to accomplish the same purpose and, not infrequently, tracheotomy is necessary.

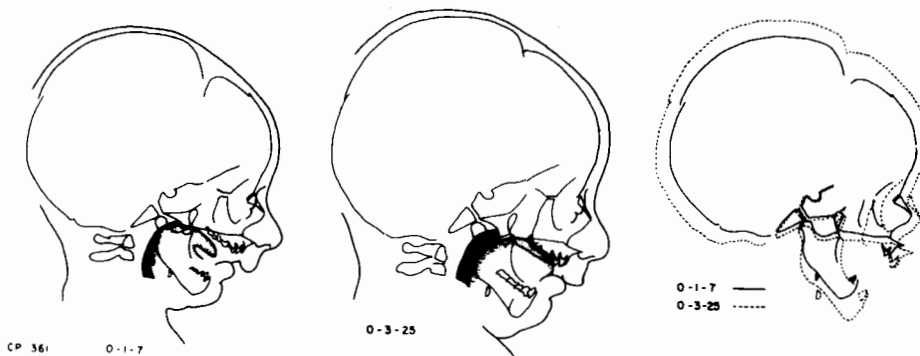

FIGURE 1c. The Pierre Robin Syndrome. Representative growth pattern of the mandible. The downward and forward growth of the mandible between 1 month, 7 days of age and 3 months, 25 days significantly improved the airway dimension.

Such a child and the subsequent changes in the airway coincident with growth of the mandible are seen in Figure 3. The latest observation certainly suggests a normal facial profile with no pathologic narrowing of the hypopharyngeal space.

Two developmentally-oriented clinical observations are worth noting about these children with the Pierre Robin Syndrome. On the one hand, they illustrate that some birth defects are self-correcting in time and, therefore, require primarily supportive therapy during a critical period. Recently published data about children with interventricular septal cardiac defects is similarly illustrative of this phenomenon since here, too, changes in the direction of spontaneous closure frequently take place as growth progresses. The second point is related to the probable impact of mild to moderate chronic oxygen deprivation or brief recurrent but severe anoxia on these children. With experiences suggesting associated palatal and pharyngeal neuro-muscular dysfunction in some patients with isolated cleft palate, the impact of their earlier functional disturbance may be a major causative factor to subsequent unintelligible speech development and certainly should be a factor of inquiry.

B. Feeding Problems

Feeding children with clefts should not be a minor concern for the pediatrician; nevertheless, this speaker would dwell on the subject only to the extent of a few positive statements. Although much has been said about the need for special advice and assistive devices for these children, it is surprising how often mothers, not so informed, escape difficulties when they intuitively approach their children with patience, a soft nipple, and then let the infant's tongue do the work. Intruding palatal appliances and depriving these infants of intra-oral sensory experiences, however, seems to be a compulsion of some of our associates in this field. When persistent feeding difficulties do occur, they are more often due to complications of brain damage, maldevelopment of the nervous system involving the pathways for deglutition, or respiratory tract anomalies, as in the Pierre Robin Syndrome. These comments, of course,

vastly oversimplify the factors involved in the early feeding experiences of children with cleft lip and palate. Not the least important, although in the psycho-analytic realm, is the impact on emotional development and possibly speech development of children who have distorted mother-infant symbiotic relationships revolving around the feeding period. This, of course, is a subject for another time.

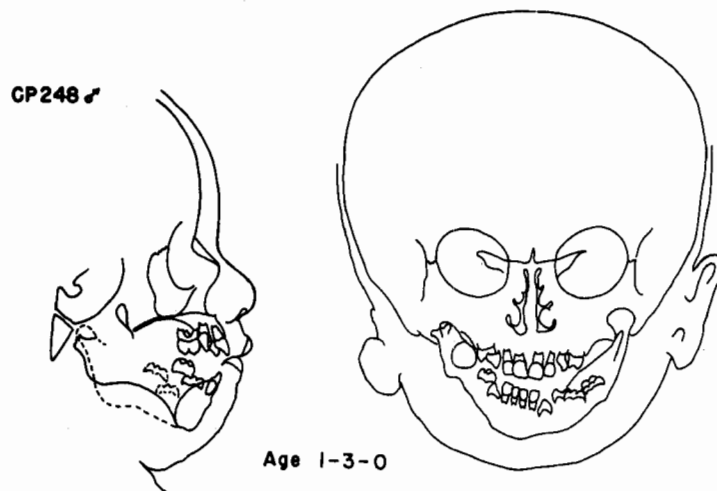

FIGURE 2. Child with a microtia syndrome. Photograph illustrating the malformation of the right pinna with inferior displacement of the parts. (Stenosis of external auditory meatus and canal not visible). Tracing of lateral and frontal cephaloentgenogram illustrating hypoplasia of mandibular condyle and shift of midpoint of mandible toward affected side.

C. Other Congenital Defects

During this postnatal period many congenital anomalies are often apparent. For purposes of illustration, four varieties are presented: first, the group with

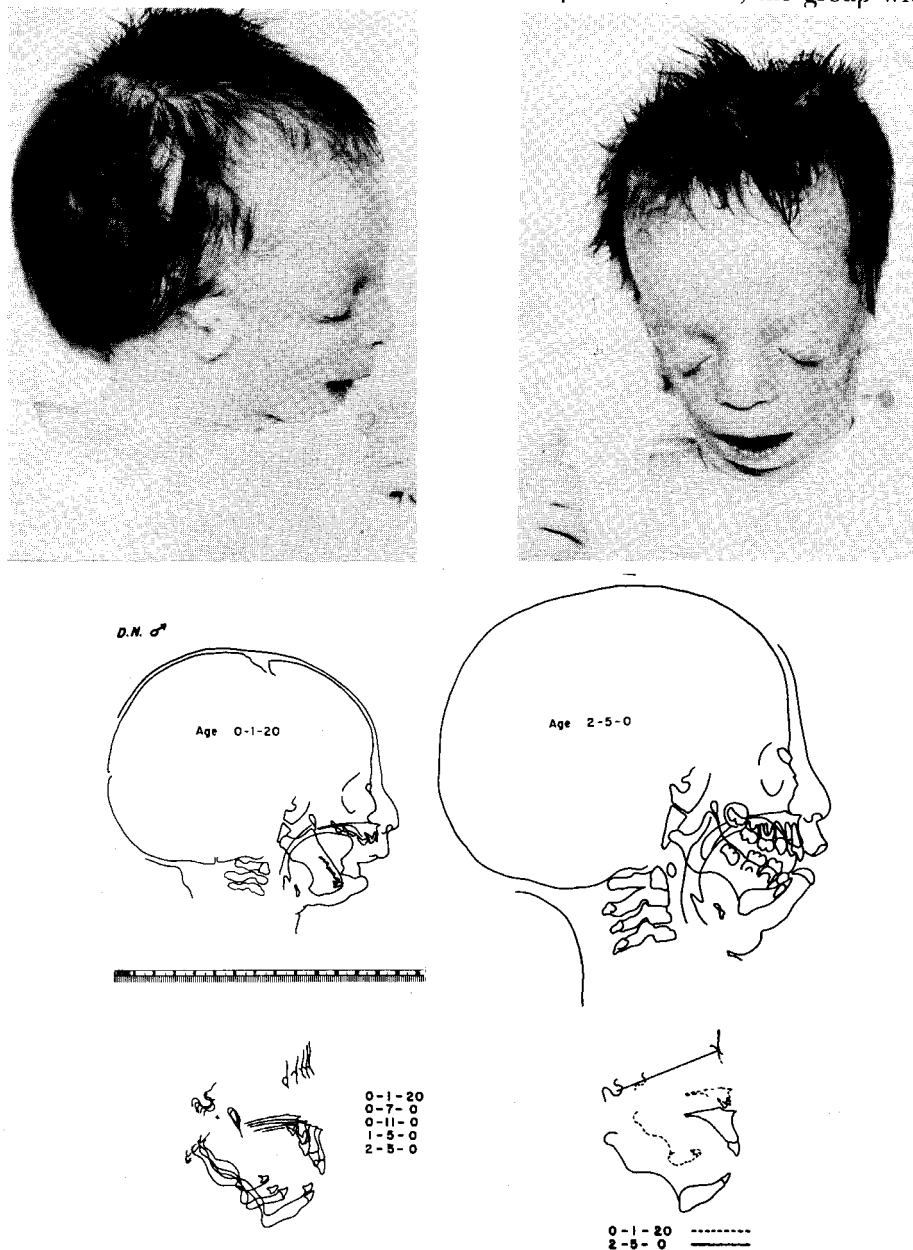

FIGURE 3. Child with a mandibulo-facial dysostosis illustrating the ophthalmic, auricular, malar, and mandibular manifestation of the syndrome. Lateral cephaloroentgenometric tracings reveal mandibular growth expression.

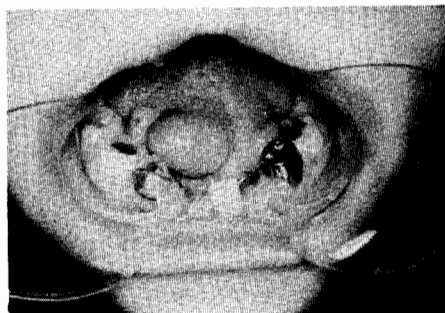

FIGURE 4. Child with oral-facial-digital syndrome illustrating anomalies of tongue and buccal mucosa.

defects in other tissues or organs of branchial origin; second, those with multiple defects and demonstrable chromosomal abnormality; those with defects involving the central nervous system and, last, those with defects in structures distant to the cleft. Every conceivable combination can occur, of course.

Children with defects in other derivatives of the 1st and 2nd branchial arch or cleft are not uncommon in most cleft palate centers. The child with a *microtia syndrome* is representative.

Figure 4 reveals the obvious malformation of an ear and some of the differences in growth of the mandible on each side. A fuller description would include the aplasia or hypoplasia of the ipsilateral condyle, hypoplasia of the temporal bone on the same side associated with lack of development, and pneumatization of the mastoid and petrous portions, stenotic or atretic external auditory canals, possible maldevelopment of the ossicles; hypoplasia of the facial bones, mimetic musculature, muscles of mastication, and disturbance of facial nerve function on the affected side; macrostomia may occur with blind fistula extending toward the tragus of the ear.

Significant to cleft palate habilitation is the need to be concerned with the added facial deformity which is progressive since one side grows normally and the other does not; the 60 dB hearing loss on the affected side; the mandibular function distortion which requires special treatment and not in the least with a cleft velum which may be smaller in size and lacking in motor innervation on the side of the microtia.

Figure 5 demonstrates a child with a mandibulo-facial-dysostosis. Superficially similar but essentially different entities, these children have bilateral air conduction hearing loss, mandibular, facial bone, and ophthalmological defects. Because of occasional facial clefts, macrostomia, and an abnormally high arched palate resembling a cleft, they are not infrequently referred for multidisciplinary care to a cleft palate center, more frequently, to a hearing clinic.

An entity recently much publicized and probably not uncommon to all centers is the OFD Syndrome (Figure 6) characterized by the association of multiple oral, facial, and digital deformities. All of the reported cases involve females and include in some a familial pattern. The oral deformity consists of a submucous cleft of the primary and secondary palate and a ragged eccentric

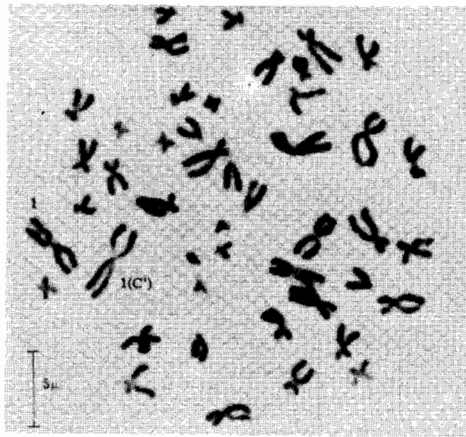

FIGURE 5a. Chromosome pattern of one child with OFD Syndrome. Chromosome 1(C¹) represents a possible insertion finding (case 165).

cleft of the velum, the tongue is bifid or multifid, often bound down to the floor of the mouth with pedunculated polyps containing tongue musculature on the dorsal surface; another characteristic is the presence of multiple labio-alveolar thick frena which seem to cut into the dental ridges. The upper lip often has a central cleft, the columellar tissue is deficient, and the hands have a variety of minor deformities. Half of these children at least are variously mentally retarded with organic CNS pathology.

What has been significant about one family in the sample at the University of Illinois is the demonstration of similar chromosomal aberrations in a mother and child. Figure 7 presents what is described as a partial trisomy with an insertion defect. Figure 8 separates out the involved chromosomes, labeled the No. 1 Chromosome of the mother and child, for purposes of comparison. Dr. Patau from the University of Wisconsin offers the description that one arm of one of the two No. 1 Chromosomes is definitely too large and is structurally abnormal close to the centromere. In this region the chromatids tend to be unusually thin and more closely paired than in the other segments. The donor of this segment was shown by Patau to be a Chromosome C from the C group. (6-12 Denver.)

The literature is rapidly filling up with other demonstrations of trisomies. The 13-15 group and the 16-18 group have had associated clefts of the lip and/or palate. What appears to be significant from our standpoint about these children with chromosomal aberrations is the multiplicity and severity of the defects and often the poor prognosis for life.

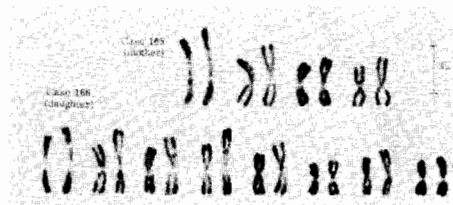

FIGURE 5b. Comparison of No. 1 chromosomes in one mother (case 165) and child (case 166) with OFD Syndrome. In each pair: left—normal chromosome; right—insertion chromosome.

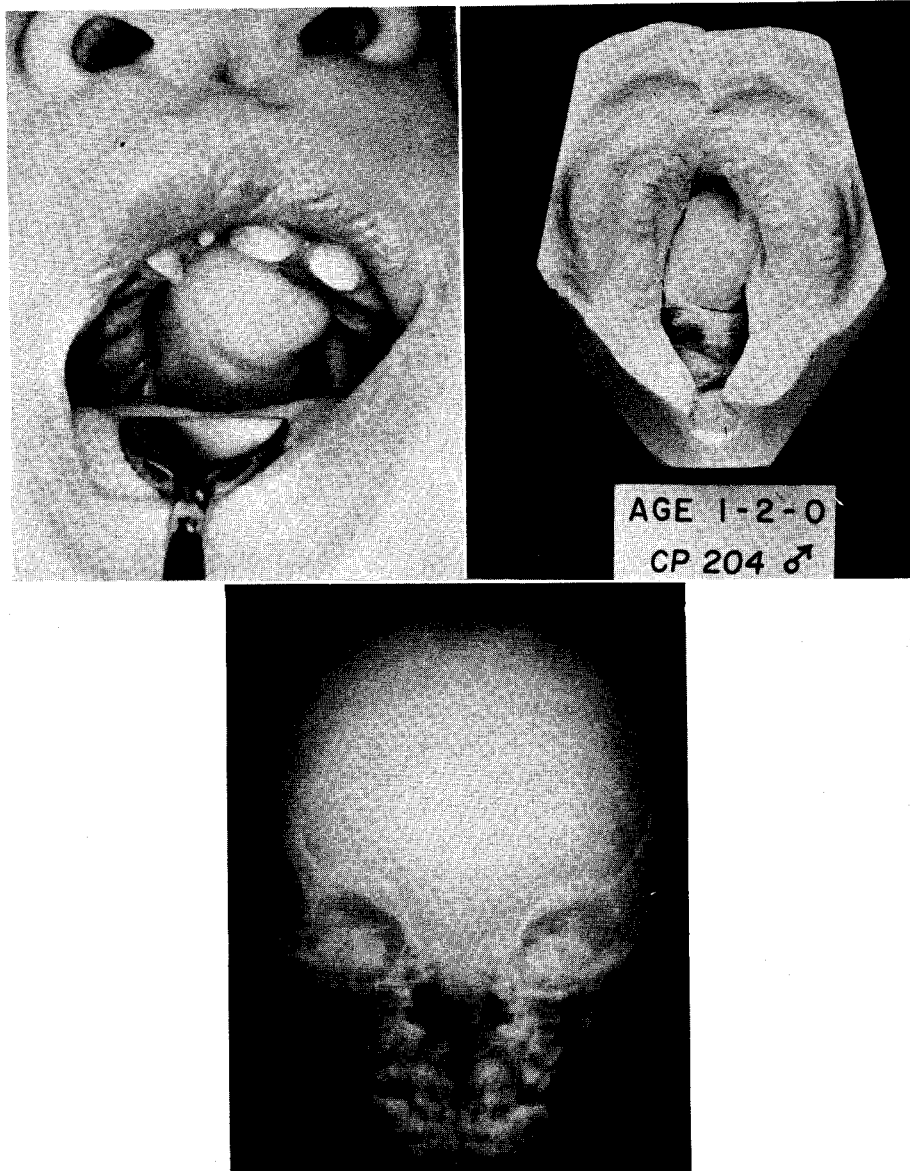

FIGURE 6. Cleft palate and encephalocele. Note the large mass protruding between the cleft parts.

Anomalies involving CNS defects and cleft palate are illustrated in Figure 9 by a child with an encephalocele protruding into the nasal cavity through the clefted velum. A rare situation is that of a child with a nasopharyngeal teratoma, cleft palate, and a micro-tongue duplication (Figure 10).

There are many other deformities which could be shown revealing the

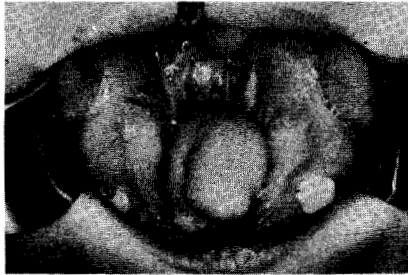
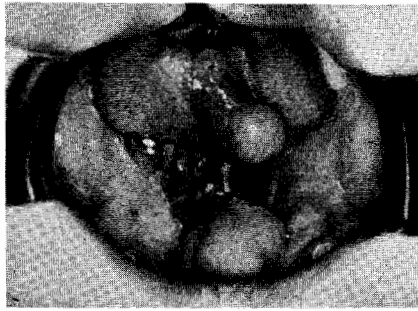

FIGURE 7. Cleft palate and nasopharyngeal teratoma. The mass of the keratoma protrudes between the cleft; note also the accessory diminutive tongue arising from the midline of the primary tongue.

multiplicity of anomalies to be encountered in this group. At this point, it is not necessary to do more than point out that other skeletal defects, genitourinary anomalies, inborn errors of metabolism, and cardiac defects, to mention a few, are a part of the heritage of some of these children.

Presentation of the various illustrations of anomalies in their various combinations should have some point beyond case history recording. One that needs to be made to the medical profession, I would single out my own colleagues, and certainly not to this assembly, is that the treatment and priorities we establish in habilitating these children with multiple handicaps should place communication skills in proper perspective. Not infrequently we still project ourselves to repeated efforts of a surgical nature while ignoring the delicate physical and psycho-social relationships required for speech and language and personality development.

Later Infancy and Childhood Period

Beyond the early infancy period with its characteristic focus on birth defects, other problems may emerge as growth and development continue. Taking as a frame of reference some 2,000 children with oral clefts in our state's cripple children's agency, four categories of concomitant physical conditions have required special consideration during cleft palate habilitation.

A. Malformations Affecting Vital Organs

The most obvious defects which relegate cleft palate habilitation to a lesser priority are those which chronically affect the function of vital organs, such as the heart, lungs, kidney, for example. Justification of the priority rating is

seldom necessary if the child remains in a chronic decompensated state or has a poor life expectancy. Nevertheless, with the advent of modern anesthesia and the combination of skilled plastic surgeons and dental prosthetists, many services can be offered if the parties to the child's multi-dimensional medical care would come together. The emphasis naturally should be on those who have a reasonable prognosis.

B. Hearing Loss, Dental Caries, Psycho-Social Problems

The relevance of this triad as a special concern is evident by the separate presentation at this conference by speakers who will detail their experiences with these complications. It could be stressed, however, that none of these conditions are inevitable consequences in this population. With the warning we have about the sensitivity of these cleft children to such secondary handicaps and the prophylactic and early treatment opportunities increasingly available, there can be an irreducible minimum goal to the prevalence of such complications. In this regard, one of our basic needs is to establish a follow-up system to safeguard the gains made or which could be made.

Somewhat parenthetically it can be added that restorative dental and otologic treatment services in Illinois, and probably most other states, are usually provided at a community level and thereby are separated from the controls related to other aspects of cleft palate services. In our communications with the local practitioners so often we need emphasize tissue salvage. Many dentists still have a relaxed attitude toward deciduous teeth while on the other hand some otologists and many family doctors have a militant attitude toward the tonsils and adenoids. Saving both teeth and the lymphoid tissue may have an important bearing on future treatment plans to which this audience could well attest.

C. Acquired Other Handicaps

A third category of problem which is undoubtedly a minimal experience for the individual specialists but which looms larger in our agency program is the association of other acquired handicaps with cleft palate — handicaps related to the fact that children have broad exposure to diverse noxious influences. Most childhood accidents and infections are taken in stride by this group; however, rheumatic fever, rheumatoid arthritis, and the osteochondroses, to mention a few, play havoc with orderly cleft palate habilitation planning which so often requires getting the child to the right service at the right time. Again, while priorities of care need re-evaluation and postponements are inevitable, the previous program should not be dropped but instead, more imaginatively, carried out under, and notwithstanding, the circumstances. This is easier said than done, however.

D. Neurological Disturbances

Worthy of separate mention is the child with a cleft palate and a sensory, motor, intellectual, and/or perceptual neurological disturbance. Here, too, there is a need for multidisciplinary evaluation, establishment of priorities, and highly individualized therapeutic planning. Cerebral palsy in association with

a cleft is an especially complex problem. Less involved are those whose basic problem is intellectual retardation. This conference cannot dwell on this theme except to emphasize the need for keeping intelligible speech development in proper perspectives for this group and the application that surgery and speech prostheses may have for these children in certain circumstances.

A more provocative subject is that group of children with subtle neuro-motor-neurosensory-perceptual disturbances and cleft palate, who despite sophisticated approaches to speech habilitation are speech failures. This population and the dilemma they pose does not lend itself to generalization of interpretation, and our knowledge of the genesis of their problem is as obscure as the particulars of their disorder. Nevertheless, in this group there are those with what appears to be a focalized neuropathy involving the oropharyngeal neuro-muscular complex, motor, sensory, or both, and as another, often separate, group those complicated by a learning disturbance on a perceptual disorder basis. Although these children are not rare among the cleft palate population and are the research and therapeutic concern of the speech pathologist primarily, the necessity to be aware of such exceptional circumstances needs little emphasis.

CONCLUSION

This brief presentation has focused on a number of characteristics of the cleft palate child population which may merit special attention during an habilitation program. Although most children with clefts present problems primarily referable to this malformation, a large spectrum of other complications may also be found in this group.

REFERENCES

- FOGH-ANDERSON, P., *Inheritance of Harelip and Cleft Palate*. Copenhagen: Nyt Nordisk Forlag, Arnold Busck (1942).
- LUTZ, K. R., and MOOR, F. B., A study of factors in the occurrence of cleft palate. *J. Speech Hearing Dis.*, **20**, 271 (1955).
- LAMY, M., and FREZAL, J., The frequency of congenital malformations. *Congenital Malformations*, Int. Medical Congress, Ltd., J. B. Lippincott Co., Philadelphia (1961).
- NEEL, J. V., A study of major congenital defects in Japanese infants. *Am. J. Human Genet.*, **10**, 398 (1958).
- MCINTOSH, R., MERRITT, K. K., RICHARDS, M. R., SAMUELS, M. H., and BELLOWS, M. T., The incidence of congenital malformations: A study of 5,964 pregnancies. *Pediatrics*, **14**, 505 (1954).
- LAUTERSTEIN, A. M., and MENDELSON, M. M., An Analysis of Caries Experience of 285 Cleft Palate Children. To be published.
- SPIESTERSBACH, D. C., LIERLE, D. M., MOLL, E. I., and PRATHER, W. F., Hearing loss in children with cleft palates. *Plast. & Reconstr. Surg.*, **30**, 336-347, 1962.
- RUSS, A. L., The clinical psychologist in the habilitation of the cleft palate patient. *J. Speech Hearing Dis.*, **23**, 561-576 (1958).
- RUSS, A. L., PRUZANSKY, S., LIS, E. F. and PATAU, K. The oral-facial-digital syndrome. *Pediatrics*, **29**, 985-995 (1962).

PSYCHOSOCIAL ASPECTS OF CLEFT PALATE

GRANT T. PHIPPS

State University of New York at Buffalo, Buffalo, New York

Our first efforts to help our fellow man who had the misfortune to be born with a cleft palate were to repair the fault through the construction of prostheses and through surgical procedures. Their failure to restore adequate speech function led to our activities in this area. When speech therapy was less effective than anticipated, we became concerned about the psychological and social problems associated with cleft palate, which we felt might be factors in the unsatisfactory results achieved.

During the last year or so, I have heard quite a number of people say that we should be more concerned about the psychosocial problems of the individual with a cleft palate. This prompted me to review the literature in this area in an attempt to find out what is known about the problem. The contributions, I find, fall into two general classes: those which logically assess the situation and those based upon controlled studies.

DISCUSSION

On the logical or common-sense bases for assuming that there is a problem, we find the opinion of many experienced clinicians who are in clear-cut agreement that very severe psychosocial problems do exist for these individuals. In contrast to this, the conclusions in the reports based upon controlled studies of psychosocial variables are inconsistent. Some found cleft palate had an effect upon the variables being studied; others did not. However, none of these studies seemed to indicate the severity of maladjustment which those using the logical approach say must exist. This contradiction should lead us to do further studies aimed at clarifying the issues. After we have quickly reviewed the work that has already been reported, we will consider some unusual approaches being used in experiments in this area.

I have used the term logical because many authors have pointed out that the individual with a cleft palate must have a psychosocial problem. It is only logical, they argue, to assume that such a problem must exist for an individual who suffers from such a physical and vocal disability. Harkins has expressed it as follows:

"He (the cleft palate individual) is a person who for a great many reasons finds personal and social adjustment very difficult. Expressed more fully, he is a person who is unhappy, uncomfortable, and unhealthy. He is gravely handicapped in his competition with normal persons in earning a living; he is at a serious disadvantage in winning the respect of his associates, and he is discouraged from forming close and rewarding friendships." (Harkins, 1946)

Others have said cleft palate children find it difficult to compete with normal children, therefore their social adjustment is frequently very poor. Their withdrawn behavior has been attributed to their facial deformity which constantly marks them as different from their associates. It has been said that the dread of ridicule and mocking during recitation in school is often enough to scar their personalities and to mark them as things apart. As a result they become self-conscious, increasingly sensitive, and maladjusted to their environment and, as they grow older, with this mental attitude they become economic and social failures. They are said to be especially likely to suffer from feelings of social inadequacy. Such feelings not only interfere seriously with their ability to form normal speech patterns but also reduce the speed of carry-over of the new patterns into the real life situation and intensify the problem of relapse in speech therapy. It has also been said that these are individuals whose misfortune is certain to have a marked effect on their personalities since it sets them off from their families as queer children. Thus the logical view has been stated in a variety of ways, but the central theme is always that people with cleft palates *must* suffer from severe social and psychological problems.

Controlled Studies

The cleft palate deformity could potentially affect any and all psychological aspects of the afflicted person and his adjustment to society. The controlled studies reviewed can conveniently be grouped into three clusters, each addressed to different psychological or social variables. Investigators have been concerned with the effect of cleft palate on the intelligence of the child, on his personal adjustment, and on his parents' reactions to him and his problem. We will now consider the literature on each of these three points in some detail.

First, let us look at the relationship between cleft palate and intelligence. Here we find some agreement among the investigators, at least on one point: that cleft palate children consistently score 2 to 11 IQ points below the mean on both the Stanford-Binet intelligence test and the Wechsler Intelligence Scale for Children. The Stanford-Binet test was used in two investigations, one by Lewis (1961), the other one by Means and Irwin (1954), to assess the intellectual capacity of cleft palate children between 4 and 16 years of age. Both studies report impairment which ranged from 6 to 10 points. Two other studies, one by Goodstein (1961) and one by Tisza (1958), both utilized the WISC which gives a verbal, a motor, and a total or full scale IQ. Goodstein found that the cleft palate children scored 6 to 11 points lower than a matched control group and that both verbal and motor IQ scores were lower for the experimental group. Tisza's group of cleft palate children with a mean IQ of 98 showed the least impairment of intellectual functioning. Birch (1952) reports that of 27 cleft palate children tested in Pittsburgh and 19 tested at Pennsylvania State University, most scored within the normal IQ range. However, of those scoring outside the normal range, more were below average than were above.

Three of these studies compared the two sub-groups of affected children

— those with cleft palate only and those with both cleft palate and cleft lip. The evidence here is contradictory. The study by Goodstein (1961) reports that children with cleft palate only were significantly more impaired intellectually than those with both cleft palate and cleft lip. The other two studies (Lewis, 1961; Means and Irwin, 1954) failed to corroborate this finding.

The role of other anomalies in the intellectual impairment of cleft palate children has not been clearly spelled out. Both Lewis (1961) and Means and Irwin (1954) report significant or near-significant differences in IQ between those cleft palate children with hearing loss and those with no loss. In both cases the children with hearing loss obtained the lower scores. It should be noted that both these studies employed the Stanford-Binet Intelligence Test, which places particularly heavy emphasis on verbal abilities, especially in the older age ranges.

To summarize the results of these investigations concerning the intellectual capacity of the cleft palate child, we may say that the performance of cleft palate children on IQ tests which place emphasis on verbal skills shows impairment of from 2 to 11 IQ points. Even if we accept these tests as valid indicators of the native intellectual capacity of cleft palate children, we are still faced with the conclusion that the mean IQ of cleft palate children is within the normal range of intellectual functioning as defined by Wechsler (1944). We cannot, therefore, on the basis of existing experimental evidence, ascribe severe intellectual impairment to cleft palate. Accurate assessment of the intellectual abilities of these children, using intelligence tests which do not rely heavily on verbal abilities and which rule out or control for anomalies such as hearing loss, remains to be done.

Adjustment Studies

The articles concerning personal and social adjustment were directed to two different questions. First, does the cleft palate child differ in personal and social adjustment from the normal child? Secondly, does the cleft palate child differ in personal and social adjustment from children with other physical disabilities?

Sydney (1951) administered a number of tests to a group of 21 cleft palate children in an attempt to ascertain their social adjustment. The level of social maturity attained by the cleft group was appropriate for their chronological age. There were no clear-cut or consistent differences between the cleft palate children and normal children on any of the five instruments employed. Sydney says:

“When one considers the extreme range of social adjustment that can be found in people who give evidence of no physical defect; when one observes the social disability of some individuals who appear to have a better than average fund of social, cultural, economic and physical resources; and particularly when one witnesses the adequacy of the social adjustment of people who suffer more gross and incapacitating handicaps than cleft palate, one is impressed with the precarious nature of concluding without strong evidence that a cleft palate is necessarily debilitating.”

Sydney's research offers an answer to the question "Does the cleft palate child differ from the normal child in his adjustment?" That answer is a resounding "NO!" Using a different approach, cross validation, Birch (1952) failed to find any cases of cleft palate or cleft lip among 600 cases of maladjusted children referred to a psychological clinic. Furthermore, he reported that a survey of the literature dealing with emotionally and educationally maladjusted children revealed little or no reference to children with cleft palates. In addition, Ruess (1958) reports the rates of mental retardation, emotional disturbance, school problems, and giftedness found in cleft palate groups were the same as those found in the general population.

In comparing the personalities of cleft palate children with those of children having other disabilities, Hackbush (1951) used several projective tests. No significant differences were found and it was concluded that there is probably no such thing as a unique cleft palate personality. This finding is in agreement with Ruess (1958) who states that no specific personality characteristics are necessarily related to a specific physical defect.

Therefore, on the basis of the existing research evidence, we cannot assume a cleft palate leads to a particular pattern of psychological maladjustment. Furthermore, there is no conclusive evidence that cleft palate children differ from normal children in personal and social adjustment.

Parents' Reactions

Among the factors that exert major influences on the development of any child are the attitudes of the parents toward the child and the behaviors that follow from these attitudes. It is not surprising, therefore, that several investigators have chosen to focus their investigations on the parents of the cleft palate child. How do the parents react to the birth of a child afflicted in such a way?

One group of investigators found that many mothers felt some deficiency in themselves, such as deprivation of food or love, was responsible for the congenital deformity (Tisza, Silverstone, Rosenblum and Haulon, 1958). Another study (Tisza and Gumpertz, 1962) concludes that mothers of cleft palate children react with strong feelings of disappointment and resentment upon finding out that they have had a deformed child. Moffat (1951) states that it is doubtful if any parent is ever able to accept completely the "different" baby. Rejection of the cleft palate child was also investigated by Hill (1956) who found that parents of children with only cleft lips gave fewer rejection responses on an attitude scale than did parents of children with either the cleft palate only or those with both cleft palate and cleft lips.

The answer to the question of how parents react to the birth of a cleft palate child seems to be two-fold. The mothers feel responsible for the deformity and both parents tend to harbor feelings of resentment and rejection toward the child. Of course, these feelings of resentment and rejection on the part of parents of normal children are not unknown phenomena. To cite an extreme example, Sears, Maccoby, and Levin (1957) found that as high as 68% of

suburban mothers expressed either mixed feelings or displeasure when they learned that they were pregnant. If we are to consider feelings of resentment and rejection on the part of the parents as important factors in the psychological development of the cleft palate child, then we must first establish that these feelings occur in the experimental group significantly more often or to a significantly greater degree than they do in a random sample of parents. This has not been reported. We are forced to conclude that it has not been clearly demonstrated that parents of cleft palate children harbor feelings that are more negative than those held by parents of normal children.

Different Methodologies

Now that we have reviewed some of the work on the psychosocial aspects of cleft palate that has been reported, let us consider some different methodologies now being used in this area. One of the experiments I referred to earlier as having an unusual approach is based on the assumption that the cleft palate child is handicapped intellectually basically not because of any lack of native ability, but because of the difficulty in acquiring verbal skills. Therefore, a verbal conditioning study will be set up to check the speed of learning of two matched groups of children, one cleft palate and one noncleft palate. This is an operant conditioning study where the effect will be measured by the subsequent rate of learning. The important point to note in this study is that it will directly test the child's ability to acquire verbal responses rather than inferring past difficulties in verbal learning on the basis of current function as is done in an IQ test.

The other experiment to which I referred is rather unique in that psychological stress on pregnant animals will be studied as an independent variable and the incidents of cleft palate in the offspring as the dependent variable. There have been previous efforts along these lines, but usually the stress has been a short-term or a one-trial affair. The proposed study will use conventional conditioning procedures to establish psychological stress for the animals, and this stress will be continued for a more extended period of time than has previously been used. It is obvious that this study is attempting to expose animals to a type of stress which is somewhat like the psychological stress to which humans are at times subjected. It looks like a tricky study to me and I wish them luck, but I certainly am happy to see someone starting to investigate psychological variables in this fashion.

Another approach to the problem, and one with which I am sure many of you are familiar, is the standardized interview used by Spriestersbach (1961). This technique includes 715 questions for the mother, 450 questions for the father, and 86 questions for the cleft palate child if he is over 10 years of age. This investigator has also used the same interview to gather base-line data from a large number of matched control group families. Bearing in mind the limitations of this technique which have been carefully listed by the author, I have high hopes that it will give us much needed information on the psychosocial problems of the cleft palate child and his family as well as supply the

badly needed normative data from matched families. In addition, because of its great breadth, I feel that it may identify relevant variables which should be the subject of experimental study and which we have previously overlooked.

SUMMARY

Having examined the logical basis for assuming that psychosocial problems do exist and having found clinical opinion practically unanimous that these problems must be severe, we went on to examine the controlled studies reported in the literature which in general failed to find these severe problems in any of the areas investigated. Now, how do we interpret this apparent conflict? On the basis of the reported research there are three possible interpretations: first, it may be that we have not been measuring the appropriate psychosocial variables in our studies and we may look to newer techniques like the one used by Spriestersbach to direct us to the relevant ones; second, the instruments we have used may not be measuring the significant psychosocial variables and we may find that laboratory studies will get around this difficulty; and third, the psychosocial problems of the cleft palate individual may not be unique nor as severe as has been concluded on the clinical-logical basis and a brief consideration of this point is in order.

It seems to me that if we are convinced that something exists in the ambiguous area of psychodiagnosis, and if we look hard enough for it, we are sure to find it. Certainly, if we give enough personality tests to anyone, with or without a cleft palate, his scores on one or more of the scales will, on the basis of chance alone, fall in the abnormal range. We should, then, beware of making too much of a score which falls outside the normal range on a particular scale. Conversely, if we have a child with a psychosocial problem and we find he also has a hole in the roof of his mouth, we should not jump to the conclusion that the relationship between the two is one of cause and effect. I believe, therefore, that the clinician should be more cautious in drawing his conclusions concerning the presence and the severity of psychosocial problems in the cleft palate child.

In conclusion then, I have found a marked discrepancy between clinical-logical opinion and research evidence on the frequency and severity of psychosocial problems of children with cleft palates, but I have not been able to locate the cause of this discrepancy. My personal hope for the clarification of this issue lies in further research, both of the type which has already been done and through some newer, more imaginative methodologies. I realize it is a cliché to say that one's hope for the future is based on more research, but I can find no other solution to the problem. With the establishment throughout America of several research-oriented cleft palate centers, well staffed with personnel who are concerned with the psychosocial aspects of the problem, I have high hopes that the next few years will see a great move forward in this area.

REFERENCES

- BIRCH, J., Personality characteristics of individuals with cleft palate: research needs. *Bull. Amer. Assoc. for Cleft Palate Rehabilitation*, **2**, 5-6 (1952).
- GOODSTEIN, L. D., Intellectual impairment in children with cleft palates. *J. Speech Hearing Res.*, **4**, 287-294 (1961).
- HACKBUSH, FLORENTINE., Psychological studies of cleft palate patients. *Cleft Palate Bulletin*, **7**, 7 (1951).
- HARKINS, C. S., The responsibility of the prosthodontist in the treatment of the cleft palate patient. *Amer. J. Ortho. & Oral Surgery*, **32**, 684-687 (1946).
- HILL, M. J., An investigation of the attitudes and information possessed by parents of children with clefts of the lip and palate. *Cleft Palate Bulletin*, **6**, 3-4 (1956).
- LEWIS, RUTH, A survey of the intelligence of cleft palate children in Ontario. Paper presented at Amer. Assoc. for Cleft Palate Rehabilitation in Montreal, Canada, May (1961).
- MEANS, BETTY, and IRWIN, J. V., An analysis of certain measures of intelligence and hearing in a sample of the Wisconsin cleft palate population. *Bull. Amer. Assoc. for Cleft Palate Rehabilitation*, **4**, 2 (1954).
- MOFFAT, HELEN M., Counseling parents of cleft palate children. *Bull. Amer. Assoc. for Cleft Palate Rehabilitation*, **7**, 7-8 (1951).
- RUESS, A. L., The clinical psychologist in the rehabilitation of the cleft palate patient. *J. Speech Hearing Dis.*, **23**, 561-576 (1958).
- SEARS, R. R., MACCOBY, ELEANOR E., and LEVIN, H., *Patterns of child-rearing*. Evanston, Ill.: Row, Peterson and Co. (1957).
- SPIESTERSBACH, D. C., Evaluation of a technique for investigating the psycho-social aspects of the "cleft palate problem." *Congenital Anomalies of the Face and Associated Structures*. Samuel Pruzansky (ed.), Springfield, Ill.: Charles C. Thomas, 345-366 (1961).
- SYDNEY, RUTH A., *An evaluation of the social adjustment of a group of children born with cleft palate*. Ph. D. Dissertation, Univ. of Pittsburgh (1951).
- TISZA, VERONICA B., SILVERSTONE, BETTY, ROSENBLUM, GERSHEN, and HAULON, NANCY., Psychiatric observations of children with cleft palate. *Amer. J. Orthopsychiat.*, **28**, 416-423 (1958).
- TISZA, VERONICA B., and GUMPERTZ, ELIZABETH, The parents' reaction to the birth and early care of children with cleft palate. *Pediatrics*, **30**, 83-90 (1962).
- WECHSLER, D., *The measurement of adult intelligence*. Baltimore: Williams and Wilkins, 3rd ed. (1944).

THE EFFECTS OF OROFACIAL ANOMALIES ON THE SPEECH PROCESS

D. C. SPRIESTERSBACH

University of Iowa, Iowa City, Iowa

This paper will survey existing knowledge concerning the effects of orofacial anomalies on the speech process and point out some of the areas where further research is most urgently needed. Particular attention will be given to cleft palate in view of the fact that it occurs frequently and has a marked impact upon the speech processes.

This material should be considered in the light of the discussion of normal speech processes presented here by Curtis (1963). An attempt will be made to highlight a conviction that understanding of the normal processes is prerequisite to understanding the disruptions of the speech processes of individuals with orofacial anomalies. I will reflect a bias that too many therapeutic approaches developed for individuals with these types of problems do not fully take into account information concerning the normal processes and the attempts of speakers with structural deviations to produce satisfactory acoustic signals by compensatory mechanisms. Understanding of the speech problems of individuals with orofacial anomalies, in my view, does not require special theories and processes of verbal behavior nor the hypothesizing of the presence of little men to make the adjustments required for speech. I shall also attempt to identify some of the areas where direct generalization from the processes observed in normal speakers, or from those of speakers with similar speech characteristics presumably not resulting from anatomical or physiological deviations, must be made with caution, if at all.

This presentation will not include an extensive discussion of the role of learning and other psychosocial factors in determining the nature of the speech behavior of persons with orofacial anomalies. However, it must be recognized that these factors may be of considerable significance in given instances and that there may be important interactions between those factors that are structural and those that are psychological in origin. Some of these interactions may be disrupted because of the modification or absence of proprioceptive or kinesthetic cues. They may also be disrupted or modified because the speech problems prevent or limit the psychological rewards that acceptable speech responses provide. In my view the whole person approach is still valid. I shall concentrate, however, on the anatomical and physiological aspects of the problems of these speakers because of the limitations of time.

The therapeutic procedures used in modifying the speech behavior of these individuals also will not be discussed, in part because of limitations in time. More importantly, however, they will not be discussed because of a conviction that priority must be given to the diagnostic evaluation of these speakers. This conviction stems from another conviction that, in most cases, surgical and dental procedures and skills are available which can provide the anatomical and physiological requisites for speech if the speech pathologists can identify the nature of the problem and specify the changes, both physical and psychological, that need to be made. We must not forget that the paramount reason for the surgical repair or obturation of the palatal cleft is to provide adequate structures for speech. If, by working with our medical and dental teammates, we are able to achieve satisfactory speech structures, the magnitude of our therapeutic program can be reduced accordingly.

Even though these convictions may have validity, it must also be recognized that we must do more than make diagnostic evaluations. Specifying the problem at any point in time is not enough in the long run. The clinician is constantly plagued with evaluations that must take into account the patient's potential for change without any further physical management. And so we are concerned with prognoses. Answers in this area come from longitudinal research which involves, in most instances, evaluation of changes stemming from some type of therapeutic process. It is possible that, at some future date, we will devote a great deal of our research energy to the evaluation of this process. However, it would seem premature to do so before we have achieved reasonable success in describing and understanding the nature of the presenting problem.

Major research efforts in the area of cleft palate can be justified on several counts. First, as previous speakers have indicated, it is realistic to look forward to excellent physical habilitative results. The professional team has been formed in many parts of the country; the individual members of the team have the requisite skills; the patients with whom we work typically possess the potential for becoming productive members of society. But there are still too many places in this country where the care of these individuals is less than adequate, and where realistic objectives of care are not being achieved. There are still too many interested professional persons who insist on working in professional isolation; there are still too many teams that aren't really teams but aggregations of individuals; there are still too many professional persons who are satisfied with things as they are and proceed somewhat aimlessly and ineptly through a program of care which, hopefully, will achieve reasonably satisfactory levels of habilitation.

Can we be satisfied with our present ability to predict the consequences of a particular dental and surgical procedure? Can we be satisfied with the criteria and techniques we are currently using for evaluating the speech adequacy, or the potential for speech, of our speakers with clefts? Can we be satisfied with the specifications we currently have concerning the requirements for nasal, oral and pharyngeal structures for speech, hearing and deglutition? Can we be satisfied with our discussions of the

merits of various physical management techniques, as if contrasting their effectiveness, or must we look further for common denominator factors which will improve the validity of the decisions we make? . . . I would answer in the negative, that we cannot be satisfied with our current levels and standards of care. (Spriestersbach, 1962)

We cannot, of course, legislate the specific nature of the care of individuals with clefts. But we can, through aggressive programs of research and the effective application of these findings, demonstrate increasingly high levels of care that will be emulated with increasing frequency over the country.

The speech pathologists face a particularly awesome responsibility for the validation of habilitative procedures and the upgrading of the levels of care of individuals with clefts. As I have indicated earlier and as many have said long before I came on the scene, speech is the paramount reason for closing the cleft. If we take this responsibility seriously, we must recognize that we are in the appropriate position to specify when further physical management procedures are required and when we have arrived at a satisfactory state of physical habilitation for the acquisition of satisfactory speech. It is apparent that a great deal of further research is needed before we arrive at the stage where we can accept this responsibility with confidence.

THE SPEECH PROBLEM

Before discussing the specific nature of the problem, I will speak of the problem of sampling. I do this because of a conviction that our research in the area of cleft palate has been contradictory and inconclusive in great part because we have failed to recognize important issues related to the homogeneity of the samples we have studied. Typically we have studied individuals with some kind of cleft ranging from a cleft lip to a small cleft of the soft palate, with all degrees of extent and combinations of involvements in between. We have included persons with open palatal clefts and persons with acceptable velopharyngeal mechanisms. We have included individuals with a wide range of conditions of the teeth and other facial structures. We have also included persons who differ considerably on psychosocial factors. We have assumed that "there is some inherent, universal commonality among individuals who are born with a cleft lip and/or palate." (Spriestersbach, Moll, and Morris, 1964)

We have all known about the intimate, dynamic relationships between the various valves of the oral and nasal cavities, the sizes and configurations of the oral and nasal cavities, and the various structures that work with these valves and modify the size and shape of the cavities of the head and neck. Yet in most of our speech research to date, we proceeded as though we were unaware of these relationships. For example, we have studied the tongue carriage of individuals with clefts by including subjects with unoperated cleft palates, with short palates, and with repaired, normally functioning palates. We have assumed that the averages of various measurements of tongue carriage would tell us something about the mechanism involved. We

have been startled when we found that some other investigators, with different subjects (and, I might add, subjects equally as heterogeneous) obtained different results.

* The differences in articulation skills between individuals with various types of clefts point up one area where there is an absence of homogeneity among patients. Bzoch (1956), Coughlin (1956), Starr (1956), and Spriestersbach, Moll, and Morris (1961)* found that the palate-only group had lower articulation scores than the lip and palate group. Byrne, Shelton, and Diedrich (1961) found differences in the opposite direction. Individuals with cleft-lips-only have been found to have essentially normal articulation skills (Spriestersbach, Moll, and Morris, 1961). I think it is safe to assume that all of these investigators were competent and used appropriate measurement techniques. If this assumption is acceptable, then we must ask why the Kansas group found differences which were opposite to those of the other investigators cited. Is that particular finding the result of a biased sampling? If the studies were replicated would the same results be obtained? Or are the differences in the findings due to different criteria in selecting patients for management? Does the Kansas group use management techniques which are more effective with individuals in the palate-only group? These are more than academic questions. Their ultimate answers will undoubtedly influence the nature of the physical management procedures we will use in the future.*

We must also be aware that the speech behavior we sample may not be representative of this behavior under other conditions. The papers of Moll (page 129) and Hardy (page 141) bear on this question. For example, it has been well documented that speakers with cleft palates articulate sounds correctly more often when the task is less complex (Morris, Spriestersbach, and Darley, 1961; Spriestersbach, Darley, and Rouse, 1956; Spriestersbach, Moll, and Morris, 1961). Are we interested, then, in sampling that behavior which is typical of the connected speech or which has been so structured that we are able to measure the best possible efforts of the speaker? If we allow variations in the rate of speech (McDermott, 1962) and effort (Tucker, 1963), we may obtain variations in the adequacy of the speech responses.* To what degree do we need to control these aspects of the speech behavior to insure that we can make meaningful inter-group and intra-subject comparisons? Lack of control over such variables may lead to erroneous conclusions or, at the very least, confusing and inconsistent findings that result in costly delays in decision making and costly replication of studies.

It is well to remember that the purposes of studies vary and that research designs are determined by the purposes. Some studies are exploratory because of the lack of information concerning relevant variables and appropriate sub-classifications of the population. Obviously these studies cannot be designed with precision. But most studies are not exploratory although we like to call many of them surveys. Even when we do surveys, however, we are not relieved of the obligation for determining in advance of the study how we propose

to use the data. Of what value is a survey of the articulation errors of individuals with all types of clefts and with all degrees of structural adequacy at the time of the survey? How will data from such a study help us better understand the etiology of the speech errors and make predictions about the course of the behavior following certain types of habilitative actions. It is my hope that we will become increasingly sensitive to the problems of sampling so that we will be able to provide more valid answers for our problems with less expenditure of time and effort.

The Articulation Problem

Let us turn to the consideration of the nature and characteristics of the articulation errors of speakers with cleft palates. In this instance we are concerned with the acceptability of particular sounds as examples of given phonemes. Unfortunately, the data available for review deals primarily with entire populations of speakers with clefts rather than homogenous subgroups. The data may be summarized as follows:

1. Individuals with clefts are generally retarded in articulation skills. Spriestersbach, Darley, and Rouse (1956) found that 21 of 25 children were retarded in articulation skills when they were compared to norms for children of the same age, sex, and socioeconomic status. Counihan (1960), studying individuals who ranged in age from 13 to 23 years, found that 11 of his 55 subjects fell below the norms of three-year-olds in articulation development.

2. Some types of sounds are more defective than others:

(a) Vowels are seldom defective if the criterion employed is phonemic acceptability. Admittedly, many of the vowels of speakers with cleft palates are nasal. (b) The adequacy of production of the consonants differs according to the manner-of-production classifications. Studies of different speakers conducted at different institutions have obtained surprisingly similar results (McWilliams, 1958; Spriestersbach, Darley, and Rouse, 1956; Spriestersbach, Moll, and Morris, 1961). The results presented in Table 1 are reasonably typical of the findings. It can be seen that the percentages of correct consonants range from 91% for the nasals, 79% for the glides, 71% for the stop-plosives, 49% for the fricatives, to 47% for the affricates. (c) Consonants are produced correctly more often when they occur as singles than when they occur as

TABLE 1. Mean percentages of consonant elements, classified according to manner of production, which were produced correctly by the total group and by the subjects classified by pressure ratios.*

<i>Subject Classification</i>	<i>Nasals</i>	<i>Glides</i>	<i>Stop Plosives</i>	<i>Fricatives</i>	<i>Affricates</i>
Total Group	91	79	71	49	47
Pressure Ratios					
.90 or more	96	89	85	66	65
.51 to .89	88	75	64	37	40
.50 or less	84	77	58	40	35

elements of blends (Counihan, 1960; Morris, Spriestersbach, and Darley, 1961; Spriestersbach, Darley, and Rouse, 1956; Spriestersbach, Moll, and Morris, 1961). (d) Voiced consonants are articulated correctly more often than their voiceless cognates. The one exception is the finding of the Iowa group who studied speakers ranging in age from 3 to 16 years. They found that voiceless fricatives were articulated correctly more often than the voiced fricatives by their subjects. However, McWilliams (1958) found that adults produced all types of voiced consonants correctly more often than the voiceless cognates. This difference between the two studies may be primarily the result of differences in the maturation of the two groups. (Templin (1957) has shown that /s/ is typically mastered at an earlier age than /z/. (e) There is not a consistent relationship between the place of articulation and the relative frequency of consonant errors.) While Counihan (1956) and Starr (1956) concluded that tongue-tip-complex sounds were more defective than those involving other tongue placements, examination of their data reveals that all of the sounds in question were fricatives. It may be that other factors, to be discussed shortly, are of greater etiological significance than placement, per se. Furthermore, no consistent differentiation in the correctness of articulation is observed between the front, middle, and back plosives (Subtelny and Subtelny, 1959).

Compare with article

3. Certain types of misarticulations are more prevalent than others. Glottal stops are frequently substituted for other sounds, particularly plosives (Sherman, Spriestersbach, and Noll, 1959). Omission of sounds occurs more frequently than substitutions and distortions (Bzoch, 1956; Counihan, 1956; Spriestersbach, Darley, and Rouse, 1956; Spriestersbach, Moll and Morris, 1961; Starr, 1956) and most particularly when the sound occurs as an element in a blend (Spriestersbach, Moll, and Morris, 1961). Fricatives and, to a lesser degree, plosives are distorted by the nasal emission of air, a phenomenon which is properly identified with articulation rather than with voice quality (Counihan, 1960; McDonald and Koeppe-Baker, 1951). The substitution of the pharyngeal fricative for other fricatives, primarily /s/ and /z/ (Bzoch, 1956; Counihan 1956; Morley, 1962; and Renfrew, 1960), and the lateralization of /s/ (Greene, 1960; Renfrew, 1960) have also been reported.

See in 1961

(4) There is considerable intra-subject and inter-group variability in the articulation abilities of individuals with clefts (McDermott, 1962; McWilliams, 1958; Spriestersbach, Darley, and Rouse, 1956). In fact, Spriestersbach, Darley, and Rouse report that their subjects repeated the same error more than twice in only 5% of the instances in which errors occurred. Table 2 illustrates the finding that there are differences in the articulation proficiency of individuals with different types of clefts and with different abilities for impounding intra-oral breath pressure. It has also been shown that inter-group differences are present when cleft palate speakers are classified according to the type of physical management (Byrne, Shelton, and Diedrich, 1961). It is possible that inter-group differences would be observed if these speakers were classi-

TABLE 2. Mean percentages of consonant elements of the Templin-Darley Diagnostic Test of Articulation produced correctly by the subject groups which were classified on the basis of type of cleft and pressure ratio, as indicated.*

<i>Subject Classification</i>	<i>N</i>	<i>Mean Percentage</i>	<i>Range of Percentages</i>
General Type of Cleft			
Lip Cleft Only	9	97.44	91 to 100
Lip and Palate Cleft	85	69.32	6 to 100
Palate Cleft Only	29	61.31	8 to 100
Type of Palate-Only Cleft			
Soft Palate Cleft	15	65.07	22 to 100
Hard and Soft Palate Cleft	14	57.29	8 to 100
Type of Lip Cleft			
Unilateral	53	70.81	6 to 100
Bilateral	32	66.86	10 to 100
Pressure Ratios			
.90 or more	49	81.40	39 to 100
.51 to .89	18	61.00	6 to 100
.50 or less	23	57.91	26 to 100

fied according to the age of management and the adequacy of velopharyngeal closure.

The Etiological Bases for the Articulation Problems

Etiological explanations of the articulation problems of individuals with clefts must be consistent with the pattern of errors which we have just reviewed. The main etiological factors include the following:

1. *Inadequate Intra-oral Breath Pressure as the Result of Velopharyngeal Incompetence.* Many studies too numerous to mention have found that individuals with repaired cleft palates tend to have palates that are short or immobile or both which frequently do not make an effective contact with the posterior and lateral walls of the pharynx. The resulting incompetence of the velopharyngeal valving mechanism provides an explanation for the articulation problems related to voicing, the manner of consonant articulation, and the type of articulation errors. For example, it has been demonstrated that more intra-oral breath pressure is required for the production of fricatives, plosives, and voiceless sounds than for other types of sounds (Black, 1950). Furthermore, it seems logical that sounds requiring intra-oral pressure would be omitted rather than distorted, particularly if gross incompetence existed, or that attempts would be made to impound air in some other portion of the system, such as the glottis for the glottal stop substitutions, when velopharyngeal incompetence is present. Finally, the frequent observation of distortions resulting from nasally emitted air is consistent with this condition.

It has been well documented that ability to impound intraoral breath pressure and the degree of velopharyngeal closure are related to articulation skills in the cleft palate population. Table 3 illustrates this relationship.

TABLE 3. Mean percentages of consonant elements as singles and in blends produced correctly by the total subject group and by the subjects classified by pressure ratio.*

<i>Subject Classification</i>	<i>N</i>	<i>Singles</i>	<i>Blends</i>	<i>Difference</i>
Total Group	114	70.68	63.89	6.79
Pressure Ratios				
.90 or more	49	84.20	78.59	5.61
.51 to .89	18	65.89	56.11	9.78
.50 or less	23	62.65	53.17	9.48

*From Spriestersbach, Moll and Morris (38)

The two groups with pressure ratios of .51 to .89 and of .50 or less did not differ significantly in articulation ability; however, both of these groups were poorer in articulation skills than children with pressure ratios of .90 or above. That this variable may be dichotomous partially explains the relatively low correlation of .40 found by Spriestersbach and Powers between wet-spirometer ratios and articulation test scores. Since ability to impound oral pressure is related to the adequacy of velopharyngeal closure, the dichotomous nature of oral pressure ability would also partially account for the low correlations reported between velopharyngeal opening and consonant articulation. Subtelný and Subtelný (1959) have also reported a higher relationship between the amount of velopharyngeal opening and the correct production of stop-plosives than of fricatives. The difference in the pattern of misarticulations of stop-plosives and fricatives observed in the study are consistent with these findings. In summary, it may be that a speaker with a cleft palate either obtains the degree of velopharyngeal closure necessary for satisfactory production of the various types of consonant sounds or does not (Spriestersbach, Moll, and Morris, 1961).

The relatively low correlations between pressure ratios, measures of velopharyngeal closure, and articulation skills should not be interpreted to mean that the relationships are of little significance. In fact, one might adopt the point of view that the relationships are surprisingly strong under the circumstances. The articulation scores, for example, are computed on the basis of the adequacy of articulation of all the sounds tested, many of which do not require any significant amount of intra-oral breath pressure. In addition, VanDemark's study (1964) indicates that, while most articulation errors of speakers with clefts tend to be related to velopharyngeal function, some of the errors, such as glide errors, are probably related to maturation. It should also be noted that we have used continuous measures of closure and have assumed a linear relationship between closure and articulation test scores. If the relationship is curvilinear and if the closure variable is dichotomous, we should not expect to find high correlations. Recent data (Brandt and Morris, in press) show, however, that the hypothesis of nonlinearity can not be accepted except for /u/ and the plosives.

Thus it can be concluded that variations in velopharyngeal competence account for a major portion of the variance in the articulatory behavior of speakers with cleft palates.

✓ 2. *Deformities of the Lips and Deviations in the Relationship of Teeth and the Dental Arches.* The evidence that is available supports the point of view that deviations of the lips and dental structures are not, in general, important causes of the articulation problems of individuals with clefts. This position is supported by the following facts:

(a) Those with clefts of the palate-only clearly have better dentition but poorer articulation (Bzoch, 1956; Counihan, 1956; Spriestersbach, Moll, and Morris, 1961; Starr, 1956). (b) Those with clefts of the lip-only have essentially normal articulation (Spriestersbach, Moll, and Morris, 1961). (c) Several investigators have found little relationship between dental deviations and articulation errors (Bzoch, 1956; Subtelny and Subtelny, 1959). (d) Dental deviations do not provide a logical basis for the explanation of the pattern of articulation errors that exist. For example, dental deviations do not provide a logical explanation for the pattern of voicing errors that have been observed by many investigators.

3. *Organic Involvement or Functional Misuse of the Tongue.* Berry (1949) suggested that individuals with clefts may have a kind of submucous cleft of the tongue which may account for their articulation problems. However, Matthews and Byrne (1953) showed rather conclusively that individuals with clefts were able to manipulate their tongues for nonspeech acts as well as their matched controls. In this case, too, such possible lingual involvements do not provide a logical explanation for the pattern of articulation errors observed. We have already noted that the tongue-tip sounds, with the exception of /n/, are frequently defective. However, these sounds also demand relatively high intra-oral breath pressure.

Several studies concern the carriage of the tongue in the oral cavity (Buck, 1951; McDonald and Koeppe-Baker, 1951; Subtelny, 1956). Some have suggested that the tongue is carried lower in the oral cavity, others that it is carried more posteriorly, and others have suggested that the dorsum of the tongue is retracted and elevated. However, most of these studies have ignored the concurrent adequacy of the velopharyngeal mechanisms of the subjects studied and, it would appear, have also ignored the dynamic relations that exist between these two articulatory mechanisms. Commenting on this point Powers says:

. . . the level of present knowledge concerning the relationships between structural variations and deficiencies is such that much more research is needed before it can be determined to what extent measurements can be grouped and averaged without direct reference to specific physiological and anatomical conditions of a given speaker. (Powers, 1962)

4. *Nasal and Pharyngeal Obstructions.* It is clear that enlarged adenoids and tonsils may serve to obstruct the flow of air through the oral and nasal cavities. Enlarged tonsils may possibly contribute to the speech problems of speakers with clefts, particularly if they have velopharyngeal incompetence, by causing more of the air and acoustic energy to be transmitted through the nasal cavities than would otherwise be the case. Enlarged adenoids, on the contrary, typically assist in the accomplishment of velopharyngeal closure by providing a compensatory structure for the short, immobile palate. The deviated septum, the collapsed ala, and chronically inflamed nasal mucosa may block the passage of air through the nasal cavity. This blockage may be so complete that denasal speech is the result. Such is usually not the case, how-

ever. On the contrary, anterior obstruction of the nasal cavities may provide an effective compensatory obstruction for the short, immobile palate and the resulting incompetence of the velopharyngeal port mechanism.

5. *Manner of Speaking.* There are numerous observations, largely of a clinical nature, concerning the relationship between rate and speaking effort, and the relative adequacy of articulation of speakers with cleft palate. It has been suggested that decreasing the speaking rate and increasing the effort level will frequently improve the adequacy of the articulation of these speakers. There is some research evidence (McDermott, 1962; Tucker, 1963) that such adjustment of the speech patterns may be appropriate in improving the adequacy of articulation to a degree. It has also been noted (Counihan, 1960; Morris, Spriestersbach, and Darley, 1961; Spriestersbach, Moll, and Morris, 1961) that the adequacy of articulation is related to some degree to the complexity of the articulatory task. More errors have been observed on sounds when they occur as elements of blends than when they appear as single sounds. All of these observations suggest that we are frequently dealing with speech mechanisms that have marginal physiological adequacy and with many speakers who can compensate for their inadequacies when the speaking task is kept relatively simple.

6. *Hearing Loss.* Numerous studies have demonstrated that individuals with cleft palates have a higher incidence of hearing loss than is to be found in the general population. Furthermore, there is almost unanimous agreement that the loss is conductive rather than sensory-neural in nature. There is also evidence (Goetzinger, Embrey, Brooks, and Proud, 1960; Graham, 1962; Spriestersbach, Lierle, Moll, and Prather, 1962) that this loss becomes stabilized as the person gets older and that adults with cleft palates tend to have hearing acuity that falls within the normal range. In any event the nature and extent of the hearing loss probably plays little part in the articulatory problems of individuals with clefts. This is not to say, of course, that ear pathologies will not lead to the types of auditory losses which may affect the speech process if adequate medical care is not provided.

7. *Learning.* Faulty learning certainly may be of etiological significance particularly for speakers who are under eight years of age. Speakers with cleft palates are not immune from learning or developmental problems. In fact, such problems are more apt to be observed among these speakers because of the possibility of an unfavorable psychological climate resulting from communication difficulties and prolonged habilitative programs.

VanDemark (1964) has completed a multiple correlation study of speakers with cleft palates in which he evaluated the relationships between various types of articulation errors and the judgment of speech defectiveness. He found that plosive and fricative errors and nasal distortions of sounds were interrelated. He speculated that these types of errors were related to a factor involving velopharyngeal closure. He also found, however, that glide and semi-vowel errors and substitutions were interrelated. It would appear that this latter

cluster of error types is most logically relatable to a maturational factor. It should be pointed out, however, that the factor related to velopharyngeal competence accounted for most of the variance in listener judgments of the defectiveness of the speech samples.

Voice Quality Disorders

It seems quite clear that nasality is the only voice quality deviation of significance generally exhibited by speakers with cleft palates. There have been suggestions (McDonald and Koepp-Baker, 1951) that these speakers exhibit other quality deviations such as harshness and breathiness. However, no research evidence substantiates the assertion that these voice deviations are more prevalent in this type of population than in noncleft populations. It should be noted that the term nasality is used here to refer to voice quality and not to the nasal emission of air during articulation. It should also be noted that considerable evidence exists that nasality is related to the vowels being phonated. The high vowels are typically more nasal than the low vowels (Spriestersbach and Powers, 1959). This relationship is contrary to that found among noncleft, nasal speakers (Lintz and Sherman, 1961) and raises serious question concerning the generalizations that have been made from the research on nasality of noncleft speakers concerning the mechanisms which result in the nasal quality of speakers with clefts.

It appears quite clear that inadequate velopharyngeal function is the primary cause of nasal quality in speakers with cleft palates. Hagerty and Hoffmeister (1954) found correlations ranging from .60 to .78 between judgments of nasality and the degree of velopharyngeal closure. Furthermore, House and Stevens (1956) have shown that high vowels require less of a velopharyngeal opening to be perceived as nasal than do low vowels. To the degree that the speakers with clefts have velopharyngeal incompetence one would expect to find a rather direct relationship between the severity of nasalization and the height of the tongue in the oral cavity.

McDonald and Koepp-Baker have suggested that an elevated and retracted dorsum of the tongue and reduced mouth opening may be the basis for the nasal voice quality among speakers with clefts. As indicated earlier, other researchers have not confirmed these findings. It was also noted earlier that much of the reasoning of McDonald and Koepp-Baker was based on the study of noncleft, nasal speakers. It is of some interest to note that Powers (1962) found considerable variation in the labial and lingual mechanisms of selected cleft palate speakers. There is little doubt that, depending upon the particular structural and functional deficiencies of individual speakers with clefts, the mechanisms suggested by McDonald and Koepp-Baker may apply to account for the nasality in given instances.

Language Development

There is considerable evidence that speakers with cleft palates are retarded generally in the development of language skills (Morris, 1962). However,

this retardation is probably only indirectly related to orofacial anomalies of the individuals with clefts. The retardation is undoubtedly related more directly to such psychosocial factors as the speaker's feelings toward communication and interpersonal relationships which have developed as a consequence of his inability to articulate speech sounds easily and adequately and to his reactions to the cosmetic sequelae of the lip repair.

Summary

Concerning the Speech Problems

Clearly, articulation errors and nasality are the two most frequent and significant communicative problems of speakers with cleft palates. Furthermore, they are related. Falck (1955) found a correlation of .70 between them. Other researchers have noted a similar relationship and have attempted to develop techniques whereby a judgment could be made of one of the factors without having it contaminated by the presence of the other (Spriestersbach, 1955). It also seems quite clear that of the two, articulation errors are clearly the most important deterrent to effective communication.

Velopharyngeal incompetence is undoubtedly the principal factor in accounting for the articulation errors and the nasality. It should be noted that many clinicians have observed that the nasal quality of a speaker persists after the articulation errors have been corrected. It is probable that non-nasal speech requires a more precise and complete closure of the velopharyngeal mechanism than do the intra-oral breath pressure demands for satisfactory articulation of the speech sounds.

COMPENSATORY MECHANISMS

During this presentation an attempt has been made to describe briefly some of the more common types of speech deviations of speakers with clefts. This is not to say that all speakers with a given type of oral deviation will have a predictable type of speech problem. The effect of a given deviation will depend upon the nature of other deviations that may also be present. It will also depend, as a result of factors still unidentified and unspecified, upon the speaker's ability to compensate for his anatomical and physiological inadequacies. There are, to be sure, limitations in the extent of such compensations. However, I should like to discuss some of the apparent compensations that have been observed in cineradiographic films. Studies have not been undertaken to document the relative frequency of these compensations, but knowledge of them may determine the nature of some of the diagnostic and prognostic observations to be made and may assist in highlighting the effects of the anomalies on the speech processes of these individuals.

see sample The first group of compensatory mechanisms appears to be the result of difficulties in developing adequate intra-oral breath pressure for speech. Those we have observed that appear to fit in this category are:

1. *Passavant's Pad*. Hagerty and Hill (1960) did not observe the anterior movement of the posterior wall during the phonation of normal speakers.

Calnan (1954) concluded, in fact, that the mechanism occurred too low in the pharynx and lacked the necessary response characteristics to serve as an important mechanism for achieving velopharyngeal closure. However, we have found the mechanism in about one-third of our cleft cases and have arrived at the conclusion that this activity does not develop unless there is a need for greater restriction of the lumen of the pharynx in the region of the velopharyngeal port. The following film sequence demonstrates rather conclusively that, at least for the patient involved, the activity of the posterior pharyngeal wall serves a very functional purpose for speech.¹

The next film sequence demonstrates the presence of activity of the posterior wall during swallowing. It is presented here to suggest that this mechanism operates for reflexive needs as well as for speech.

2. *Tongue-palate Valving*. A number of speakers build up buccal air pressure by valving between the tongue and the soft palate. The next film sequence shows a speaker puffing out his cheeks by valving in this way. I should note that we have found about two-thirds of a rather large series of individuals with repaired cleft palates who valve this way while puffing out their cheeks. We have not made a similar study of normal speakers but we assume that the proportion valving this way during puffing would be relatively less.

The next film sequence will demonstrate tongue-palate valving during sucking. This is a more dynamic situation in which air must flow through the oral cavity. The tongue cannot maintain a continuous contact with the palate. Instead it is noted that the tongue pumps against the palate. Moll (in press) has noted similar valving mechanisms in normal speakers during sucking. This mechanism puts in question the validity of sucking as a therapeutic exercise for developing velopharyngeal competence.

The next sequence of film demonstrates tongue-palate valving during blowing. In this instance a pumping action of the tongue is noted that is similar to that in sucking. And again this valving action forces us to consider the validity of the recommendation, long since questioned by Kantner (1947), that blowing exercises are appropriate for developing the effectiveness of the velopharyngeal mechanism.

The last film sequence dealing with tongue-palate valving demonstrates some abnormal tongue activity during speaking and particularly during the articulation of stop-plosives. From this sequence it would appear that the speaker is trying to build up enough intra-buccal air pressure by this type of valving for the production of fricatives requiring intra-oral air pressure.

3. *Lingual Elevation of the Palate*. We have noted a number of speakers with immobile palates and a consequent velopharyngeal incompetence who appear to push the palate up to contact the posterior wall of the pharynx for the momentary build-up of intra-oral breath pressure. The next film sequence demonstrates this mechanism, particularly while the speaker is sustaining an /s/ sound.

¹Films were shown to the conference participants. Further references will be made to them, but none are reproducible here.

4. *Lingual Occlusion of Open Clefts.* Many persons have observed that some individuals with open clefts have surprisingly good speech. Nares constriction or obstruction of the nasal passageways may assist them in impounding intra-oral breath pressure. Some individuals also are able to occlude the open cleft momentarily with their tongue. During the next film sequence of a patient with an open cleft, the high-riding tongue can be noted during connected speech and the apparent occlusion of the cleft by the tongue while /s/ is sustained.

Morris and Smith (1962) are among those who have noted that speakers with cleft palates frequently are able to produce sounds in simple contexts such as in isolation, nonsense syllables, or words, but are unable to produce them during the rapid flow of connected speech. Such a change in behavior would seem to be especially apt to occur among those speakers who are using tongue-palate valving.

5. *Nares Constriction.* This is a common compensatory mechanism that does not need to be demonstrated. I have not seen a person with movement of the nares during speech who does not have some degree of velopharyngeal incompetence. However, this is not a sure diagnostic sign since many speakers with velopharyngeal incompetence do not develop movement of the nares.

The second group of compensations involves atypical constrictions of the oral tract to produce an acoustic signal which is similar to that of a difficult sound. A large proportion of such efforts involves sounds which require intra-oral breath pressure. Many persons, for example, have noted that glottal stops are substituted for a variety of sounds, but primarily the stop-plosives. One research study by Sherman, Spriestersbach, and Noll (1959) has confirmed these observations. Other workers, primarily our British friends, Morley (1962) and Renfrew (1960), have noted the presence of the pharyngeal fricative which presumably occurs not only because of velopharyngeal incompetence but because the tongue is displaced posteriorly as a result of the collapse of the dental arches of the maxilla or the underdevelopment of the maxilla.

Oral Anomalies Other Than Clefts

Many of the oral anomalies that we have discussed in connection with cleft palate may, of course, occur without being associated with a cleft. In summary, such isolated anomalies may involve the following structures:

- (1) Lips;
- (2) Teeth;
- (3) Size and shape of the oral cavity including the size of the oropharynx and the configuration of the palatal vault;
- (4) Palate insufficiency or immobility;
- (5) Lingual anomalies including a short frenum, lingual asymmetry, tongues too large or too small for the oral cavity, and neuromuscular deficits of the tongue. Recently we observed a speaker with a surgically repaired cleft palate who appears to have a tongue that is positioned too far posteriorly in relation to other structures of the oral cavity. Presumably such a position might also

be noted in individuals without clefts. The next film sequence deals with such a speaker. Because of the deviations of the articulatory mechanism created by the cleft in this instance it is difficult to determine if the tongue placement is directly related to any of the child's speech problems.

Time does not permit a systematic review of the effects on speech of deviations of these structures. However, I should like to suggest that too many times we have been too willing to attach etiological significance to such deviations without first insuring that there was a logical relationship between the deviation and the sounds in error. Furthermore, there is a substantial body of information that supports the contention that non-cleft speakers have an amazing ability to compensate for other types of oral deviations.

... it is frequently difficult to pin a particular type of misarticulation to a particular structural deviation in a given instance. A given structural deviation may be of significance only if it occurs as one of a constellation of deviations... No big point is to be made of a space between the upper incisors, for example, when the speaker's only misarticulation is a /w/ for /r/ substitution (Johnson, Darley, and Spriestersbach, 1963).

I do not wish to leave the impression that I feel that the oral structures do not have a normal function to perform during the production of speech. Certainly deviations of these structures can be of such a nature that the normal valvings and constrictions required for speech are difficult if not impossible. However, I am suggesting that we insure that there is a logical basis for the relationship between an oral deviation and error sounds before we institute relatively elaborate habilitative plans to deal with the deviation.

✓ SOME SUGGESTED AREAS OF RESEARCH

There are many areas in which further research concerning the effects of orofacial anomalies is needed. I will mention only a few that come immediately to mind:

1. Normative studies to document the nature of the lingual and palatal mechanisms during a variety of voluntary and reflexive tasks. We need to know more about normal swallowing, blowing, sucking, puffing, etc., before we can fully understand the behavior that we see in individuals with orofacial anomalies. We also need to reevaluate the assumption, made by many, that speech acts are essentially modifications of reflexive acts.

2. Studies of the relationships between observations of isolated, speech-related physiological responses, and connected speech. Must we have elaborate and expensive equipment in making routine diagnostic observations of these speakers or can we demonstrate that there are some relatively simple, discrete observations that can be used, at least for screening purposes?

3. Identification and validation of diagnostic procedures for determining the anatomical and physiological adequacy of the oral structures for speech.

4. Studies of the potential for the development of muscular activity and strength by appropriate therapeutic means. Can we establish some criteria which will help in the establishment of the limits of achievement in this area?

We are involved in a very costly and complex habilitative problem. It is certain that our research efforts will improve our understanding of some of the speech mechanisms and sharpen our diagnostic and prognostic acumen. The cost of the research will be small in comparison with the benefits that will stem from these efforts.

REFERENCES

- BERRY, MILDRED E., Lingual anomalies associated with palatal clefts. *J. Speech Hearing Dis.*, **14**, 359-362 (1949).
- BLACK, J. W., The pressure component in the production of consonants. *J. Speech Hearing Dis.*, **15**, 207-210 (1950).
- BRANDT, SARA D., and MORRIS, H. L., The linearity of the relationship between articulation errors and velopharyngeal incompetence. *Cleft Palate J.* (in press).
- BUCK, M. W., An x-ray study of cleft palate oral and pharyngeal structures and their functioning during vowel phonation. Ph.D. dissertation, University of Iowa (1951).
- BYRNE, MARGARET C., SHELTON, R. L., Jr., and DIEDRICH, W. M., Articulatory skill, physical management, and classification of children with cleft palates. *J. Speech Hearing Dis.*, **26**, 326-333 (1961).
- BZOGH, K. R., An investigation of the speech of pre-school cleft palate children. Ph.D. dissertation, Northwestern University (1956).
- CALNAN, J., The error of Gustav Passavant. *Plastic and Reconstructive Surgery*, **13**, 275-289 (1954).
- COUNIHAN, D. T., A clinical study of the speech efficiency and structural adequacy of operated adolescent and adult cleft palate persons. Ph.D. dissertation, Northwestern University (1956).
- COUNIHAN, D. T., Articulation skills of adolescents and adults with cleft palates. *J. Speech Hearing Dis.*, **25**, 181-187 (1960).
- CURTIS, J. F., Normal speech processes (Conference paper).
- FALCK, VILMA, Selected factors related to the ability of cleft palate speakers to convey information. Ph.D. dissertation, Pennsylvania State University (1955).
- GOETZINGER, C. P., EMBREY, J. E., BROOKS, R., and PROUD, G. O., Auditory assessment in cleft palate adults. *Acta Oto-Laryngologica*, **52**, 551-557 (1960).
- GRAHAM, M. D., A longitudinal study of ear disease and hearing loss in patients with cleft lips and palates. M.S. thesis, University of Iowa (1962).
- GREENE, MARGARET C. L., Speech analysis of 263 cleft palate cases. *J. Speech Hearing Dis.*, **25**, 43-48 (1960).
- HAGERTY, R. F., and HILL, M. J., Pharyngeal wall and palatal movement in postoperative cleft palates and normal palates. *J. Speech Hearing Res.*, **3**, 59-66 (1960).
- HAGERTY, R. F., and HOFFMEISTER, F. S., Velo-pharyngeal closure: an index of speech. *Plastic and Reconstructive Surgery*, **13**, 290-298 (1954).
- HALFOND, M. M., and BALLENGER, J. J., An audiologic and otorhinologic study of cleft lip and cleft palate cases. *Archives of Otolaryngology*, **64**, 58-62 (1956).
- HARDY, James C., Air flow and air pressure studies. (Conference paper).
- HOUSE, A. S., and STEVENS, K. N., Analog studies of the nasalization of vowels. *J. Speech Hearing Dis.*, **21**, 218-232 (1956).
- JOHNSON, W., DARLEY, F. L., and SPRIESTERSBACH, D. C., *Diagnostic Methods in Speech Pathology*. New York: Harper and Row (1963).
- KANTNER, C. E., The rationale of blowing exercises for patients with repaired cleft palates. *J. Speech Dis.*, **12**, 281-286 (1947).
- LINTZ, LOIS B., and SHERMAN, DOROTHY, Phonetic elements and perception of nasality. *J. Speech Hearing Res.*, **4**, 381-396 (1961).
- MATTHEWS, J., and BYRNE, MARGARET C., An experimental study of tongue flexibility in children with cleft palates. *J. Speech Hearing Dis.*, **18**, 43-47 (1953).
- McDERMOTT, R. P., A study of /s/ sound production by individuals with cleft palates. Ph. D. dissertation, University of Iowa (1962).

- MCDONALD, E. T., and KOEPP-BAKER, H., Cleft palate speech: an integration of research and clinical observation. *J. Speech Hearing Dis.*, 16, 9-20 (1951).
- MCWILLIAMS, BETTY JANE. Articulation problems of a group of cleft palate adults. *J. Speech Hearing Res.*, 1, 68-74 (1958).
- MOLL, K. L., Cinefluorographic study of velopharyngeal function in normals during various activities. *Cleft Palate J.* (in press).
- MOLL, K. L., Photographic and radiographic procedures in speech research. (Conference paper).
- MORLEY, MURIEL E., Cleft Palate and Speech (Fifth edition). Baltimore: Williams and Wilkins Company (1962).
- MORRIS H. L., Communication skills of children with cleft lips and palates. *J. Speech Hearing Res.*, 5, 79-90 (1962).
- MORRIS, H. L., and SMITH, JEANNE K., A multiple approach for evaluating velopharyngeal competency. *J. Speech Hearing Dis.*, 27, 218-226 (1962).
- MORRIS, H. L., SPRIESTERSBACH, D. C., and DARLEY, F. L., An articulation test for assessing competency of velopharyngeal closure. *J. Speech Hearing Res.*, 4, 48-55 (1961).
- POWERS, G. R., Cinefluorographic investigation of articulatory movements of selected individuals with cleft palates. *J. Speech Hearing Res.*, 5, 59-69 (1962).
- RENFREW, CATHERINE E., Present day problems in cleft palate speech. *Logopeden*, June (1960).
- SHERMAN, DOROTHY, SPRIESTERSBACH, D. C., and NOLL, J. D., Glottal stops in the speech of children with cleft palates. *J. Speech Hearing Dis.*, 24, 37-42 (1959).
- SPRIESTERSBACH, D. C., Professional survival groups. *Cleft Palate Bulletin*, 12, 63-66 (1962).
- SPRIESTERSBACH, D. C., Assessing nasal quality in cleft palate speech of children. *J. Speech Hearing Dis.*, 20, 266-270 (1955).
- SPRIESTERSBACH, D. C., DARLEY, F. L., and ROUSE, VERNA, Articulation of a group of children with cleft lips and palates. *J. Speech Hearing Dis.*, 21, 436-445 (1956).
- SPRIESTERSBACH, D. C., LIERLE, D. M., MOLL, K. L., and PRATHER, W. F., Hearing loss in children with cleft palates. *Plastic and Reconstructive Surgery*, 30, 336-347 (1962).
- SPRIESTERSBACH, D. C., MOLL, K. L., and MORRIS, H. L., Heterogeneity of the 'Cleft palate population' and research designs. *Cleft Palate Journal*, 1, 210-216 (1964).
- SPRIESTERSBACH, D. C., MOLL, K. L., and MORRIS, H. L., Subject classification and articulation of speakers with cleft palates. *J. Speech Hearing Res.*, 4, 362-372 (1961).
- SPRIESTERSBACH, D. C., and POWERS, G. R., Articulation skills, velopharyngeal closure, and oral breath pressure of children with cleft palates. *J. Speech Hearing Res.*, 2, 318-325 (1959).
- SPRIESTERSBACH, D. C., and POWERS, G. R., Nasality in isolated vowels and connected speech of cleft palate speakers. *J. Speech Hearing Res.*, 2, 40-45 (1959).
- STARR, C. D., A study of some of the characteristics of the speech and speech mechanisms of a group of cleft palate children. Ph.D. dissertation, Northwestern University (1956).
- SUBTELNY, JOANNE D., A laminagraphic study of nasalized vowels produced by cleft palate speakers. Ph. D. dissertation, Northwestern University (1956).
- SUBTELNY, JOANNE D., and SUBTELNY J. D., Intelligibility and associated physiological factors of cleft palate speakers. *J. Speech Hearing Res.*, 2, 353-360 (1959).
- TEMPLIN, MILDRED C., *Certain Language Skills in Children (Institute of Child Welfare Monograph Series, No. 26)*, Minneapolis: University of Minnesota Press (1957).
- TUCKER, LINDA J., Articulation variations in normal speakers with changes in vocal pitch and effort. M.A. thesis, University of Iowa (1963).
- VANDEMARK, D. R., Misarticulations and listener judgments of the speech of individuals with cleft palates. *Cleft Palate J.*, 1, 232-245 (1964).

PHOTOGRAPHIC AND RADIOGRAPHIC PROCEDURES IN SPEECH RESEARCH

KENNETH L. MOLL

University of Iowa, Iowa City, Iowa

In the past few years the number of research studies dealing primarily with speech physiology has increased. Undoubtedly this is due, in part, to a realization that inferences about the physiological aspects of speech on the basis of acoustic or perceptual analyses have certain limitations. In addition, procedures for observing the function of speech structures in a systematic and quantifiable manner also have been greatly improved in recent years and new procedures have become available. Among the research techniques which have come into wide use are those which involve the recording of information on film. In the study of speech physiology, these techniques can be separated into two general types: photographic procedures and radiographic procedures.

I will discuss variations of these two techniques as utilized in the study of speech. The first portion of this discussion will include short descriptions of methods used to obtain film records of the positions of various speech structures. Consideration then will be given to some general principles involved in the application of photographic and radiographic techniques to speech research and an evaluation of the techniques in light of the principles. No attempt will be made to describe all of the possible variations of these techniques which could be utilized. Photographs and radiographs obviously could be taken of almost any speech structure from almost any orientation. This discussion will be limited to the general types of procedures most commonly used in speech research. The discussion will not be limited, however, to only those procedures which have been used in the area of cleft palate. It is assumed that all of the techniques considered have potential application to the study of the speech process in any individual, including those with cleft lips and palates.

DISCUSSION

Photographic Techniques

Let us first consider various photographic techniques which have been utilized in the study of speech structures. These can be grouped into four general categories: (a) laryngeal photography; (b) photography of the lips; (c) intra-oral photography; and (d) photography through a surgical opening in the face.

Laryngeal Photography. Photography of the laryngeal structures has been utilized by Farnsworth (1940), Moore and VonLeden (1958), and many other investigators.¹ A superior view of the vocal folds is obtained via a laryngeal mirror placed in the oropharynx. While the mirror may elicit the subject's gag reflex, this problem usually can be overcome with training or a topical anesthesia. A light beam directed onto the mirror supplies illumination on the vocal folds and the image is photographed from the mirror by a camera, usually a motion picture camera. The illumination may be continuous or intermittent. If continuous lighting is used, the action of the folds generally is slowed by using a high-speed camera at film speeds of 3000 to 5000 frames per second. Intermittent illumination allows the use of a normal speed camera since apparent vocal fold motion is slowed due to the stroboscopic principle. During laryngeal photography the tongue must be low in the oral cavity. The subject is instructed to produce a sustained vowel, usually a sound between an /a/ and /æ/. The fundamental frequency, intensity, and other characteristics of the sound may serve as experimental or control variables.

Lip Photography. Movements of the lips during speech have been studied by a number of investigators using motion picture photography. Smith (1950) took full-face views of nasal and non-nasal speakers during vowel productions. Fujimura (1961) utilized full-face and profile cinematography to investigate lip movements on bilabial consonant sounds. Both normal and high-speed photography have been used for this purpose.

Intra-Oral Photography. Intra-oral photography also has been utilized to study the speech mechanism. The subject is instructed to open his mouth as widely as possible and the oral cavity is illuminated. Cheek retractors and a tongue depressor often are utilized so that the posterior portion of the oral cavity and the pharyngeal area can be visualized more adequately. The subject is instructed to phonate a low vowel sound, such as /a/, and either still or motion pictures are taken. Intra-oral photography provides observations of movements of the soft palate, the faucial pillars, and the posterior and lateral pharyngeal walls. It should be noted, however, that observations concerning the degree of velopharyngeal closure cannot be made reliably from intra-oral pictures. The point at which palato-pharyngeal contact is made is superior to the field of view. It also is obvious that clinical evaluations of velopharyngeal closure from direct oral examinations have the same limitation.

Photography Through Surgical Openings. Another photographic procedure which has been utilized to observe primarily the velopharyngeal mechanism (Bloomer, 1953; Calnan, 1953; Harrington, 1944) involves photography through a surgical opening in the face. The view obtained depends on the size and location of the opening.

Radiographic Procedures

Although photographic techniques are useful in the study of speech, many

¹No attempt will be made to provide a complete listing of investigators who have utilized the techniques to be discussed. Only sample references will be given.

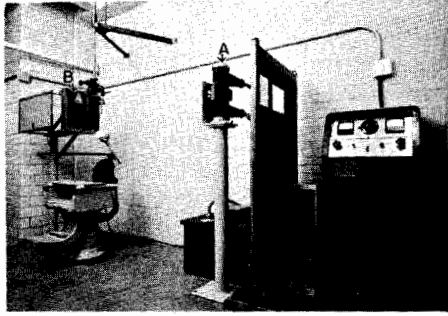

FIGURE 1. Equipment for obtaining still radiographs of the head. A, x-ray tube; B, Potter-Bucky grid and film cassette holder.

of the speech structures are not accessible for direct photography. As a result, radiographic techniques have come into wide use in speech research. The types which have been used can be grouped into three general categories: (a) normal, still x-ray procedures; (b) laminagraphic procedures; and (c) cineradiographic procedures.

Normal, Still X-Ray Procedures. For the usual still x-ray pictures the recording device is simply a film sheet of any size contained in a cassette. In most cases an intensifying screen is used in the cassette to increase film exposure. In addition, a moving grid may be used to improve structural definition.

In the study of speech still x-ray procedures have been used most often to obtain a lateral view of the speech articulatory structures (Buck, 1954; Graber, 1959; Holbrook and Carmody, 1937; Russell, 1928; Wildman, 1961).

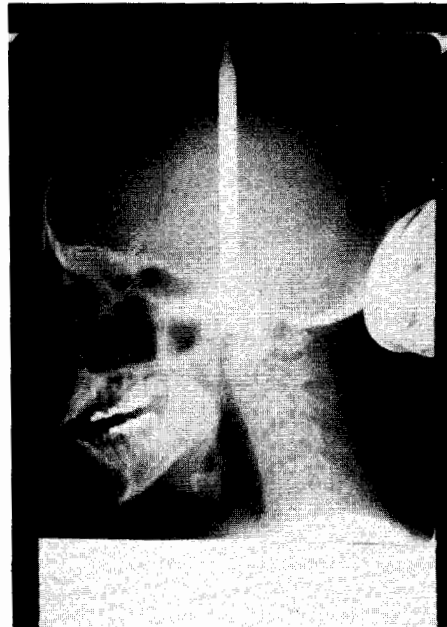

FIGURE 2. Radiograph showing a lateral view of the head.

Figure 1 shows equipment for obtaining such views. The position of the subject's head is fixed by a head positioner so that the sagittal plane is parallel to the film. The exposure usually is made during the production of a sustained speech sound and may be as short as 1/30 of a second. Lateral x-ray views of the head (Figure 2) provide views of the tongue, posterior pharyngeal wall, hard and soft palates, and other articulatory structures.

Still x-ray techniques also have been utilized to study the larynx and the breathing mechanism (Bloomer, 1936). It is also possible to obtain views other than lateral projections with these procedures. For example, antero-posterior views of the head often are obtained; however, visualization of soft tissue structures in such films is complicated by the fact that structures on all planes in the path of the x-ray beam are projected on the film. The bony structures of the skull and spinal column make it difficult to visualize the tongue, pharyngeal walls, and other speech structures.

Laminagraphic Procedures. The second group of still x-ray procedures, laminagraphic techniques, provides a cross section of structures rather than a projection of all planes. Laminagraphy involves the simultaneous rotation of the x-ray source and the film in an arc in relation to the subject. Only the anatomic plane which remains at the same distance between the source and the film during the rotation will be in focus on the film; other planes will be blurred out. The depth of the cross section obtained depends on the particular source-subject and subject-film distances used. The exposure again is made during a sustained speech sound and usually is one to two seconds in duration.

Laminagraphic procedures have been utilized to study both the articulatory (Hagerty and Hill, 1960; Subtelny and Subtelny, 1959) and laryngeal mechanisms (Hollien and Curtis, 1960). They are particularly useful for obtaining antero-posterior views of the head since bony structures such as the cervical vertebrae are blurred out. In laryngeal research, a frontal section usually is taken through the vocal folds. The thickness, angulation, and other dimensions of the folds can be observed from such films.

Cineradiographic Procedures. The third general category of radiographic procedures, cineradiography, provides motion pictures rather than still views of the speech structures. Most cineradiographic equipment now in use involves electronic intensification of the x-ray image by factors of from 1000 to 3000 times. The image then is photographed from the fluorescent output screen of the intensifier tube. A motion picture camera, either normal or high-speed, usually is used; however, a television camera can be utilized to record the image on video tape or to provide a television monitor display with subsequent photography of the monitor screen.²

Cinefluorography has been used most commonly to obtain lateral views of the articulatory structures. Figure 3 shows equipment utilized for this purpose. The subject's head again is fixed by a head positioner and the image is in-

²More complete descriptions of cinefluorographic instrumentations and procedures can be found elsewhere (Ramsey, Watson, Tristen, Weinberg, and Cornwell, 1960).

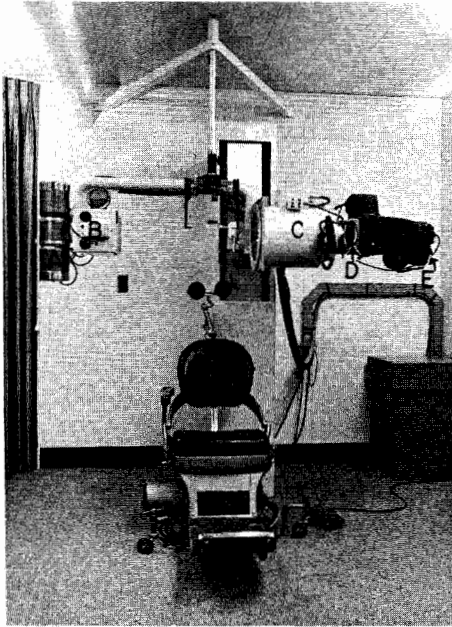

FIGURE 3. Cinefluorographic equipment: A, x-ray tube; B, x-ray beam collimator; C, 9-inch image intensifier tube; D, fluoroscopic viewer; E, Auricon, sound-on-film, 16 mm camera.

tensified by a 9-inch image intensifier tube. A motion picture camera records the images on 16mm film. Unlike the still x-ray procedures previously discussed, sustained speech sounds are not required during cinefluorography; connected speech may be utilized.

Radiation. Involved in any radiographic procedure is a potential radiation hazard to the subject. At present, the radiation involved in most procedures is minimal. For example, lateral, cephalic still x-rays can be taken with a dosage of less than 0.1 roentgen per exposure. With the cinefluorographic equipment described above, pictures at 24 frames per second on any adult subject can be obtained at a dosage of approximately 0.45 roentgens per minute. These levels are quite small in relation to the usually accepted safety limits; however, radiation safety devices should be utilized whenever possible. The radiation dosage in cineradiography can be reduced by approximately one-half by pulsing the x-ray beam synchronously with the camera shutter. Pulsing also allows the exposure time per frame to be shortened, thus reducing image blurring due to structural movements.

Although attempts always should be made to reduce the radiation dosage, the film quality required in a particular application may prohibit a large reduction. If not enough radiation is used to provide films with adequate structural definition for the particular purpose, any amount of radiation to the subject cannot be justified.

General Principles of Application

There are some basic principles which should govern the application of photographic and radiographic procedures to the study of speech physiology.

Structural Representation. The most obvious principle is that the procedure should provide an accurate visualization of the structures observed. All of these techniques are limited in relation to this principle since they provide only two-dimensional views of three-dimensional structures. In addition, all x-ray procedures, except laminagraphy, project various two-dimensional planes onto the film. If these limitations are recognized in interpretation of data, however, photographic and radiographic procedures can provide useful information about the speech structures.

Restraints on Speech Function. A second principle, closely related to the one just discussed, is that the technique used should place as few restrictions as possible on the normal activity of the speech structures. The use of intra-oral photography requires that the mouth be held open widely and that the tongue be depressed. Such a position obviously is not assumed in normal speech production. Further, it is likely that the mandibular and tongue positions required bias observations of other structures. For example, since velar elevation has been shown to be related to tongue height (Moll, 1962), movements of the velum may be restricted by holding the tongue low. The interrelationship between the lingual and pharyngeal musculature make it likely that pharyngeal activity also may be affected. Laryngeal photography involves essentially the same position as the intra-oral technique; however, it is unlikely that mandibular and lingual positions significantly affect laryngeal functioning.

Interpretation of observations made through a surgical opening in the face also must be made with caution. It should be recognized that the presence of the opening may affect the functioning of the speech structures. In addition, it is possible that the integrity of the musculature has been impaired by disease or the surgical procedure.

Head positioners utilized in radiographic procedures also result in certain restrictions of movement. It is not known, however, whether such restrictions significantly affect the normal activity of the speech structures. Moreover, head fixation is necessary if an accurate view of the structures in constant orientation is desired.

Sampling Adequacy. A third principle involved in the use of photographic radiographic procedures is that the technique used should provide an adequate sampling of the activity being investigated. Still photographs or radiographs provide only one sample and thus are severely limited in providing information about any changing event. In addition, the use of still pictures requires that only speech sounds which can be sustained be sampled, since adequate time for film exposure is necessary. This requirement prohibits the study of transient speech sounds such as stop-plosives. Further, there is evidence (Moll, 1960) that the positions of the articulatory structures, for example, are not the same for a sustained sound as they are for that sound in connected speech. Despite these disadvantages, however, still photographs or radiographs can provide useful information of various types.

Motion picture techniques are generally considered to overcome the disadvantages of still pictures; however, even cinematography may not provide adequate sampling. The term "motion" picture is a misnomer since such films involve simply a series of still pictures, not pictures of motion. The apparent movement during film projection is provided by the visual mechanism of the viewer. When viewed in this way, it is obvious that motion pictures do not provide automatically for adequate sampling of an event; the rapidity with which frames are exposed must be considered. The filming speed required depends on the structures observed and on the detail which is desired.

When using laryngeal photography a very rapid camera speed is necessary for detailed studies of individual vocal fold vibrations. Speeds of 5000 frames per second often are used (Timcke, VonLeden, and Moore, 1958). Such camera speeds necessitate greatly increased illumination levels and the use of a device for cooling the light beam. The apparent fold vibration can be slowed by stroboscopic illumination; however, it then must be assumed that all cycles sampled to provide one apparently complete vibration are identical. The finding of Moore and VonLeden (1958), that even adjacent cycles may be different in form, casts doubt on the validity of this assumption.

It also has been found necessary to use higher than normal camera speeds for lip photography. Fujimura (1961) concluded that an interframe interval of five msec or less was necessary for detailed study of lip opening during bilabial consonants. As a result, he utilized a camera speed of 240 frames per second.

It has been demonstrated that cineradiographic pictures exposed at a normal speed of 24 frames per second are not adequate for most speech research. During the production of consonant-vowel-consonant syllables, for example, only three or four frames are obtained on the vowel, even at fairly slow rates of utterance. Structural contacts on the stop phase of stop-plosive consonants can be missed completely at normal camera speed (Moll, 1960). Even if the contacts are photographed (Shelton, Brooks, Youngstrom, Diedrich, and Brooks, 1963) it is difficult to study them in detail when only one movie frame is available. The cineradiographic camera speed required appears to depend, to some degree, on the structures being observed. For example, velar movements do not appear to be as rapid and as constantly varying as those of the tongue. On the basis of Fujimura's conclusions on the desirable speed of lip photography and information on speech sound durations, it would appear that a cineradiographic camera speed of at least 200 frames per second is necessary for detailed studies of individual phonemes in connected speech. Higher camera speeds result in proportional increases in radiation; however, total exposure time of the subject can be reduced. The cinefluorographic equipment shown previously (Figure 3) is designed to provide films at camera speeds up to 200 frames per second. The radiation dosage at this speed will be approximately 6.0 roentgens per minute. In relation to adequacy of sampling it also should be noted that cineradiography involving a television

camera is limited to a sampling speed of 30 pictures per second, corresponding to the usual scanning rate of the television system.

Sound Synchronization. A fourth principle which should be considered involves synchronization of the acoustic signal with the photographic or radiographic film. A method must be available for identifying individual pictures with particular segments of speech. In still photography or radiography only a single, sustained sound is involved; however, no attempt usually is made to determine exactly where the film was exposed during the sustained sound. In motion picture techniques the sound is recorded synchronously on the film sound track or separately on a magnetic recorder. It is then possible to identify the frame or frames associated with any speech segment (Moll, 1962; Smith, 1950). Pictures also can be correlated with segments of Sonographic records if an adequate synchronization system is used (Bjork, 1961; Nylén, 1961; Truby, 1959).

Film Analysis. The fifth, and final, principle to be discussed involves methods of analyzing photographic or radiographic information. If these techniques are to be maximally useful in research, they must provide accurate, quantitative information. Still pictures generally have been analyzed by measurements of structural positions. For example, quantitative analyses of cephalic radiograms have been used for many years by the dental profession to study growth of the cranial structures. Measurements reflecting the positions and relationships of the articulatory structures also have been made from lateral, still x-rays by many investigators.

In contrast to the analysis of still films, motion pictures generally have been viewed in motion with one or more observers describing what was seen. Such description obviously represents a very gross form of analysis of unknown reliability and particularly subject to observer bias. In addition, speech is analogous to a three-ring circus; it is difficult to describe the activities with any degree of certainty. Such observations can be improved by centering attention on one structure or by using some type of rating scale (McWilliams and Bradley, 1963). Even these procedures have limitations for research purposes since it is impossible to average or to make accurate comparisons of verbal descriptions. It should not be concluded, however, that observations from films in motion have no utility; they often provide hunches and hypotheses to be tested by more precise research methodology.

A more reliable, quantitative method of analyzing motion picture films is to make measurements from individual movie frames. Although such procedures are very laborious, it has been demonstrated that reliable measures can be obtained. Fujimura (1961) and Smith (1960) made various measurements of lip opening from motion picture frames. Timcke, VonLeden, and Moore (1958) measured vocal fold opening from laryngeal movies. A number of investigators have demonstrated that reliable measures of articulatory positions can be made from single cinefluorographic frames. Thus, data quantification methods can be utilized effectively with motion picture techniques. It

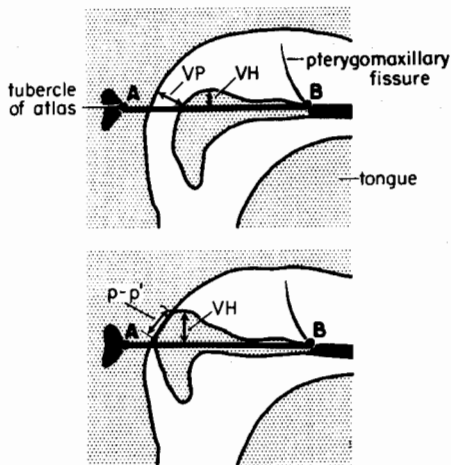

FIGURE 4. Line drawings of cinefluorographic frames showing various measurements which might be made to describe velopharyngeal function: VH, velar height above reference line A-B; P-P', extent of velopharyngeal contact; V-P, minimum velum-pharynx distance (Moll, 1962).

should be recognized, however, that certain problems are involved in such analyses. The major problem involves selection of the measures to be made. For example, when studying articulatory structures by cineradiography numerous measures could be utilized. Figure 4 shows some of the measurements which have been made to study velopharyngeal activity (Moll, 1962). Measures of the diameter of velopharyngeal opening, extent of palatopharyngeal contact, and velar height above a reference line all provide some indication of velopharyngeal function. In studying lingual positions (Figure 5) measures could be made of tongue height, the antero-posterior position of the tongue, the distance between the tongue and posterior pharyngeal wall, and many other dimensions (Tucker, 1963). It obviously is impossible, however, to select measures which will describe completely the position of such a complex structure as the tongue. At present, the model of articulation proposed by Stevens and House (1955) appears to provide the most valid measures of articulatory positions, at least as these positions are related to the acoustic

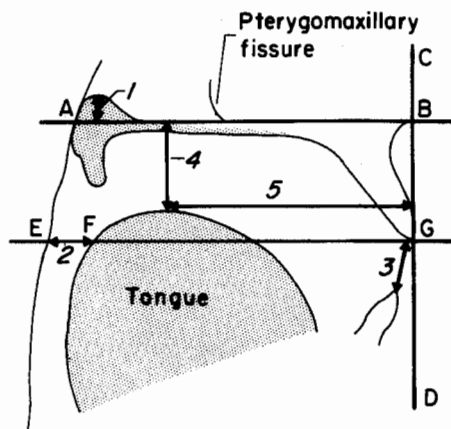

FIGURE 5. Line drawing of a cinefluorographic frame showing various measurements which might be made in studying speech articulation: 1, velar height; 2, tongue-pharynx distance; 3, incisal opening; 4, tongue height; 5, anteroposterior position of the highest point of the tongue (Tucker, 1963).

characteristics of speech. This model involves measurements of (a) the degree of vocal tract constriction at the narrowest point; (b) the distance of this minimal constriction from the glottis; (c) the area of lip opening divided by the length of the lip constriction; and (d) the area of velopharyngeal opening reflecting the degree of nasal coupling. Although some of these measures require observations in three dimensions, it is likely that close approximations to these parameters could be obtained from two-dimensional radiographic films.

An important requirement of quantitative film analysis procedures is that the structures of interest remain at a known and constant distance from the film. It is imperative that a head positioner or some other type of fixation device be used. One of the problems involved in intra-oral photography is the difficulty in determining the exact photographic enlargements of various oral structures. However, fairly constant structure-film distances can be achieved.

SUMMARY

In summary, it appears that the use of any photographic or radiographic technique in speech research should be governed by the following principles:

1. The technique should result in an accurate representation of structures.
2. It should place as few restraints as possible on the normal activity of the speech structures.
3. An adequate sampling of structural activity, preferably during connected speech, should be provided.
4. The technique should provide for correlating individual pictures with particular speech segments.
5. Film analysis procedures which result in accurate, quantitative data should be used.

It should be emphasized that photographic and radiographic procedures provide information only on structural positions; they do not represent the ultimate or complete research technique for the study of speech physiology. However, when they are utilized according to the principles discussed and in conjunction with other physiologic research techniques, acoustic and perceptual analyses, and other pertinent observations, they can provide information which will contribute to a more complete understanding of the speech process.

REFERENCES

- ASHLEY, F. L., SLOAN, R. F., HAHN, ELISE, HANAFEE, W., and MIETHKE, J., Cinefluorographic study of palatal incompetency cases during deglutition and phonation. *Plast. Reconst. Surg.*, **28**, 347-364 (1961).
- BLOOMER, H. H., A roentgenographic study of the mechanics of respiration. *Speech Monogr.*, **3**, 118-124 (1936).
- BLOOMER, H. H., Observations on palatopharyngeal movements in speech and deglutition. *J. Speech Hearing Dis.*, **18**, 230-246 (1953).
- BUCK, M., Post-operative velo-pharyngeal movements in cleft palate cases. *J. Speech Hearing Dis.*, **19**, 288-294 (1954).

- BJORK, L., Velopharyngeal function in connected speech. *Acta Radiologica*, Suppl. 202 (1961).
- CALNAN, J. S., Movements of the soft palate. *Brit. J. Plast. Surg.*, 5, 286-296 (1953).
- FARNSWORTH, D. W., High-speed motion pictures of the vocal cords. *Bell Lab. Record*, 18, 203-208 (1940).
- FUJIMURA, O., Bilabial stop and nasal consonants: a motion picture study and its acoustical implications. *J. Speech Hearing Res.*, 4, 233-247 (1961).
- GRABER, T. M., BZOCH, K. R., and AOBA, T., A functional study of the palatal and pharyngeal structures. *Angle Orthodont.*, 29, 30-40 (1959).
- HAGERTY, R. F., and HILL, M. J., Pharyngeal wall and palatal movement in postoperative cleft palates and normal palates. *J. Speech Hearing Res.*, 3, 59-66 (1960).
- HARRINGTON, R., A study of the mechanism of velopharyngeal closure. *J. Speech Dis.*, 9, 325-345 (1944).
- HOLBROOK, R. T., and CARMODY, J. F., X-ray studies of speech articulation. *Univ. Calif. Publ. Mod. Philol.*, 20, No. 4 (1937).
- HOLLIN, H., and CURTIS, J. F., A laminagraphic study of vocal pitch. *J. Speech Hearing Res.*, 3, 361-371 (1960).
- HOUSE, A. S., and STEVENS, K. N., Analog studies of the nasalization of vowels. *J. Speech Hearing Dis.*, 21, 218-232 (1956).
- MCWILLIAMS, BETTY J., and BRADLEY, DORIS P., A rating scale for evaluation of video tape recorded x-ray studies. Paper presented at 1963 Convention of American Cleft Palate Association, Washington, D.C.
- MOLL, K. L., Cinefluorographic techniques in speech research. *J. Speech Hearing Res.*, 3, 227-241 (1960).
- MOLL, K. L., Velopharyngeal closure on vowels. *J. Speech Hearing Res.*, 5, 30-37 (1962).
- MOORE, P., and VONLEDEN, H., Dynamic variations of the vibratory pattern in the normal larynx. *Folia Phoniatica*, 10, 205-238 (1958).
- NYLEN, B. O., Cleft palate and speech. *Acta Radiologica*, Suppl. 203 (1961).
- RAMSEY, G. H. S., WATSON, J. S., JR., TRISTAN, T. A., WEINBERG, S., and CORNWELL, W. S., (Editors), *Cinefluorography*. Springfield, Ill.: Charles C. Thomas (1960).
- RUSSELL, G. O., *The Vowel*. Columbus: Ohio State Univ. Press (1928).
- SHELTON, R. L., JR., BROOKS, ALTA R., YOUNGSTROM, K. A., DIEDRICH, W. M., and BROOKS, R. S., Filming speed in cinefluorographic speech study. *J. Speech Hearing Res.*, 6, 19-26 (1963).
- SMITH, G. A., A motion picture study comparing lip and jaw movement and area of mouth opening of nasal and non-nasal speakers. M.A. thesis, Univ. of Iowa (1950).
- STEVENS, K. N., and HOUSE, A. S., Development of a quantitative description of vowel articulation. *J. Acoust. Soc. Amer.*, 27, 484-493 (1955).
- SUBTELNY, JOANNE D., and SUBTELNY, J. D., Intelligibility and associated physiological factors of cleft palate speakers. *J. Speech Hearing Res.*, 2, 353-360 (1959).
- TIMCKE, R., VONLEDEN, H., and MOORE, P., Laryngeal vibrations: measurements of the glottic curve: Part I, the normal vibratory cycle. *Arch. Otolaryng.*, 68, 1-19 (1958).
- TRUBY, H. M., Acoustico-cineradiographic analysis considerations with especial reference to certain consonantal complexes. *Acta Radiologica*, Suppl. 182 (1959).
- TUCKER, LINDA J., Articulatory variations with changes in vocal pitch and effort. M.A. thesis, Univ. of Iowa (1963).
- WARREN, D. W., and HOFMANN, F. A., A cineradiographic study of velopharyngeal closure. *Plast. Reconst. Surg.*, 28, 656-669 (1961).
- WILDMAN, A. J., Analysis of tongue, soft palate, and pharyngeal wall movement. *Am. J. Orthodont.*, 47, 439-461 (1961).

AIR FLOW AND AIR PRESSURE STUDIES

JAMES C. HARDY

University of Iowa, Iowa City, Iowa

In 1950 Black reported data which suggested that greater magnitudes of intra-oral breath pressures are associated with voiceless consonant sounds and with continuant sounds than with voiced consonant sounds and stop sounds respectively. It seems improbable that Black anticipated the impact his data would eventually have upon work in the area of speech disorders. Since that time, survey studies (e.g., Spriestersbach, Darley, and Rouse, 1956; McWilliams, 1958) have indicated that speech elements most frequently misarticulated in populations of cleft palate speakers are those sounds which Black's data suggest to be associated with higher intra-oral breath pressures. Subtelny and Subtelny (1950), in a study of adult cleft palate speakers, found that none of their subjects manifested normal speech who had poor palatal function, which suggests that the inability to impound intra-oral pressure was the primary cause for the speech problem in their group of subjects. Other research (e.g., Buncke, 1959; Spriestersbach and Powers, 1959; Chase, 1960; Powers, 1962) has demonstrated that tests which are designed to assess the cleft speaker's ability to generate intra-oral air pressure have predictive value in determining whether or not that speaker has a significant velopharyngeal closure problem. Therefore, as has been reviewed in detail by Spriestersbach (1963), it now seems that inability to create and maintain intra-oral air pressure is the primary cause of articulation problems in the cleft palate population. It seems doubtful that such an understanding of the cleft problem would have been possible without Black's contribution.

With respect to the air pressure and air flow measures which have been shown to be related to velopharyngeal incompetence, two techniques for determining potential for generating intra-oral air pressure seem to be in general use. Both of these techniques utilize two expiratory efforts on the part of subject being tested. For one type of measure the subject is asked to produce one vital capacity effort through the mouth with his nostrils occluded and another with his nostrils open. If the former measure, as recorded by a spirometer, or other volume measuring instrument, is greater than the latter, it is assumed that the slight resistance created by the spirometer caused a significant portion of the expired air to be forced through an incompetent velopharyngeal port when the subject's nostrils were open. The other type of measure requires the subject to blow with maximum effort into a manometer, once with the nostrils occluded and once with the nostrils open. Again, if the latter measure is less

than the former, it is assumed that air leaked through an open velopharyngeal port.

For both of these techniques the measures are combined into a fraction with the nostrils open measure divided by the nostrils occluded measure. The extent to which the resulting value is less than one is used as an index of velopharyngeal incompetency.

The measures thus obtained have been shown to be related positively to speech problems in populations of cleft speakers. Moreover, these techniques have become accepted as tools which, when combined with other observations, aid in a definitive diagnosis of palatal malfunctioning.

Yet, these oral manometer and vital capacity measures are not as strongly related to velopharyngeal incompetence as is desirable for predictive purposes. For example, Spriestersbach and Powers (1959) reported a correlation coefficient of .50 between articulation test scores and manometer ratios. Most clinical and research workers seem to recognize that there are other variables of significance which relate to cleft palate speech problems and that there is probably insufficient information regarding the dynamics of intra-oral breath pressure and air flow from the speech mechanism to be able to design precise diagnostic measures by air flow and air pressure measuring techniques.

In view of this recognition, interest is developing in not only perfecting techniques which better predict palatal malfunction by use of air pressure and air flow measurements but also in research designed to learn more regarding the dynamics of air pressure and air flow fluctuations during speech in the oral and nasal cavities. The purpose of this paper will not be to critique the findings of the various studies which have utilized measurements of air pressure and/or air flow in diagnosis of palatal malfunction. Rather, its purpose will be to present a discussion of certain types of instrumentation, limitations of that instrumentation, and physiological variables which must be considered in planning clinical and research work utilizing measures of intra-oral air pressure and air flow to study speech physiology and aberrations thereof.

Pressure Measuring Instrumentation

Instrumentation for Measuring Intra-oral Pressures During Maximum Expiratory Efforts. As is well known, the two types of manometers routinely used for measuring pressures produced by maximum expiratory efforts are U-tube manometers filled with liquid and pressure gauges. While both are reliable and uncomplicated, their use does not allow a permanent recording to be made of the pressure values. Although a given examiner may be trained to visually read peaks of pressure with good reliability, care should be exercised in eliminating this possible source of measurement error. If precision is desired in measuring these static pressures, some type of graphic read-out system (which will be described) might be considered in order to minimize this type of error.

Instrumentation for Measuring Intra-oral Air Pressure During Speech Production. Measuring magnitudes of fluctuating pressure may be accomplished by an instrument system with three basic components: (1) a pressure

transducer, which converts pressure into a voltage, (2) amplifiers to amplify that voltage, and (3) a read-out system. However, in order that the instrumentation will present minimal interference to the articulation process, determination of intra-oral air pressure during speech production presents unique design problems.

These problems result from the necessity of placing a very small pressure sensing element (ordinarily the pressure transducer) within the vocal tract. While pressure transducers are available which are small enough to be inserted into the oral pharyngeal area with thin wires leading out the mouth, such transducers with acceptable characteristics do not seem to be available at this time. Most transducers of acceptable size do not have adequate frequency response and linearity characteristics. One such transducer with which the present speaker has personally worked had adequate frequency response and linearity; however, it was very susceptible to thermal effects. That is, minor changes in the temperature of the air surrounding the transducer caused fluctuations in the output voltage of an appreciable extent. Obviously, such a transducer would not be acceptable for detecting intra-oral air pressure fluctuations during speech production. Therefore, consideration must be given to some type of tube which is capable of transmitting pressure fluctuations to a pressure transducer outside of the vocal tract.

This consideration requires the addition of a fourth basic component to the air pressure measuring system, namely, a connecting tube. Since a wide variety of amplifiers are available commercially, and their characteristics are readily available from manufacturers, no discussion will be devoted here to selection of amplification equipment. However, selection of appropriate connecting tubes, pressure transducers, and read-out instruments deserves consideration.

Connecting Tubes. Although it may seem relatively simple to place an open ended tube which will transmit pressure to a pressure transducer into the oral cavity, it is well established that pressure sensing tubes placed in an area where air flow exists may give spuriously high pressure recordings due to the air flow impinging into the orifice of the tube (Rouse and Howe, 1953). This spuriously high pressure (stagnation pressure) is a combination of the pressure in the area plus an additional pressure created by flow into the tube. This air flow artifact may be eliminated by the use of some type of Pitot-tube (Rouse and Howe, 1953, pp. 65-67) or orienting the end of the tube in such a manner that air flow does not produce a spurious reading. Whether or not a pressure sensing tube does give spurious pressure readings when placed in a given orientation to the flow of air can be determined by empirical measurements made in a pressure chamber which is designed to provide a flow of air around the tube.

Figure 1 shows polyethylene tubing molded to fit around the pre-maxillary arch with the open end projected into the oral pharyngeal area but orientated perpendicular to the oral air stream. Such placement of the tube allows for measurement of intra-oral pressure back of the tongue for lingua alveolar and,

FIGURE 1. A polyethylene tube molded to fit around the premaxillary arch with the end perpendicular to the oral air stream. The tube is connected to a Statham PM 131 TC pressure transducer.

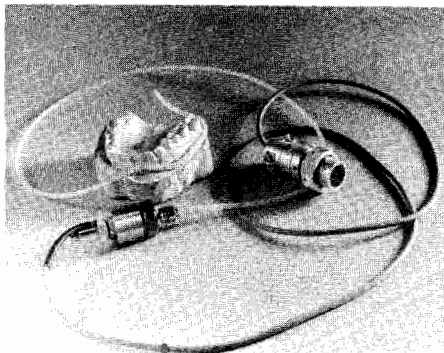

in most cases, lingua palatal sounds. A tube placed in this position which has an inside diameter of 1.524 mm has been shown to show no artifacts of air flow when the tube end was perpendicular to the direction of flow (McGlone and Hardy, 1962). The maximum rate of flow under which this determination has been made was 50 liters per minute.

In the use of a connecting tube to a pressure transducer, reduction in frequency response due to length, internal diameter, and configuration of the tube must also be considered (Stedman, 1956; Iberall, 1952). In general, the smaller the internal diameter, the longer the length, and the less straight the tube, the more there will be diminution of high frequency pressure oscillations.

It is possible to empirically determine the frequency response of such tubes in combination with the frequency response of pressure transducers used. McGlone and Hardy have determined frequency response characteristics of different types of Pitot-tubes and open-ended tubes of various length in combination with a Statham PM 131TC pressure transducer. By comparing the intensity of sine waves introduced into a Pitot-tube transducer system with the intensity of the output of that system, it was found that a connecting tube 10 inches long resulted in a mean depression of frequency response of -6.7 dB over a frequency range of 40-400 cycles per second. With a tube 30 inches long a mean attenuation of -12.5 dB was observed over that same frequency range. Most of the attenuation in both tubes was above 200 cps, but these data serve to exemplify the need to keep connecting tubes to a transducer as short as possible.

Pressure Transducers. In studying intra-oral air pressure fluctuations, it might be assumed necessary to use a transducer which has a distortion-free response up to 5,000 or 6,000 cps and therefore record the pressure fluctuations associated with acoustic phenomena. However, if the primary interest in studying intra-oral air pressure is to determine the generating force for production of acoustic phenomena associated with consonant sound production, there seems to be no need to delay such research until high frequency response transducers are available. Moreover, if the instrumentation used is sensitive enough to record an acoustic signal of relatively high frequency, the pressure tracing will be more difficult to interpret. This difficulty will arise since the

pressure tracing obtained will reflect rapidly fluctuating signals (acoustic pressures) superimposed upon a slowly fluctuating signal (intra-oral air pressure). Determination of the intra-oral pressure would then have to be made by calculating not the measured value but the mean value of the acoustic pressures. Moreover, a microphone may be used to record acoustic phenomena (speech signal) if those phenomena are of interest.

There is no information available which gives the rise and fall-time of air pressure fluctuations within the mouth during speech. A linear frequency response up to 200 cps would seem to be satisfactory to obtain an undistorted signal in the study of intra-oral air pressure during speech production.

Of equal importance to the frequency response of pressure transducers is the linearity of such transducers. While some transducers have good linearity characteristics for restricted ranges of pressures, their linearity is less acceptable at higher pressures. Obviously, a pressure transducer should be used that is linear over the pressure range of interest.

Read-Out Systems. With respect to read-out instruments, if it is accepted that 200 cps is the upper limit of the frequency response needed for the study of intra-oral air pressures, there are curvilinear paper ink-writing instruments available which are satisfactory. Moreover, some of these paper-writers are equipped with amplifiers which may eliminate the need for a preamplifier between the transducer and the read-out instrument.

There is a wide variety of read-out systems available which have higher frequency response characteristics. The pressure tracings may be recorded on magnetic tape at high tape speeds and played back into a paper-writer at a low tape speed. Such a procedure will have the effect of increasing the frequency response of the paper-writer by the ratio of the tape speeds used. For example, if the paper-writer is linear to 200 cps and the tape speeds used are 60 inches per second for recording and 1½ inches per second for play-back (a ratio of 40:1), signals displayed on paper-writer will be linear up to 8,000 cps. Utilization of tape recordings in the read-out system also provides storage of raw data which can be retained for later analysis.

Other choices for high frequency read-out systems include high speed motion picture films of an oscilloscope trace and direct writing oscillographs which utilize light-beam galvanometers and light sensitive chart papers.

Before passing on to a discussion of instrumentation for measuring air flow, some consideration of frequency response of the entire pressure measuring system is needed. No matter how good the response characteristics of any of the basic components may be, the linearity of the entire system will be limited to that of the poorest component. For example, even if a pressure transducer which has good frequency response up to 1,000 cps is used, and a read-out system which is linear to 100 cps is used, the entire system will give an undistorted response only to 100 cps.

Air Flow Measuring Instrumentation

Instrumentation for Measuring Volume Flow of Air During Maximum Ex-

piratory Efforts. Use of spirometers or other volume measuring instruments to obtain the previously described vital capacity measures does not require the examiner to read the volume measures from a rapidly moving indicator. Rather, most of the instruments available provide a dial which remains at the measured volume after the expiratory effort is made. Therefore, these instruments are not as susceptible to error due to the experimenter misreading a dial as mentioned for the manometers.

However, one source of variability in the use of these vital capacity measures may be the force with which the subject blows into them during the nostrils' open effort. In general, the rate at which air will flow through an orifice can be computed by

$$\frac{E. F.}{\Delta p} = Q,$$

where E.F. is equal to the rate at which energy is being expended, Δp is equal to $p_1 - p_2$, and Q is equal to rate of air flow. In the present application, p_1 would be the pressure "in front" of the orifice (pressure in the mouth) which is created by the resistance to the oral air flow by the weight of the spirometer bell and which is relatively constant, and p_2 would be the pressure "in back" of the orifice (or the pressure in the nasal cavity) which is atmospheric pressure and is relatively constant.¹

As can be seen from this formula, if the subject blows with unequal force for the two vital capacity efforts, the rate at which air will be expelled through an open velopharyngeal port will vary as a result. That is, if E.F. varies, Q will vary.

Chase (1960) has suggested adding more resistance to the oral air flow during the vital capacity measurements. Such a procedure would increase p_1 , and it would have the effect of forcing more air through the velopharyngeal port. Moreover, it would also lessen the effect of variations in the force with which air is expired, since as Δp becomes larger, greater values of E.F. will have a lesser effect in increasing Q . However, it should be noted that p_1 would have to be increased to an infinite resistance, such as in the manometer measures, before the variability in Q which is caused by variations in E.F. would be eliminated.

Instrumentation for Measuring Air Flow From the Speech Mechanism During Speech Production. There is similarity between those instrumentation systems for measuring intra-oral air pressure during speech production and those instrumentation systems to measure air flow from the speech mechanism during speech production. Instead of a pressure sensing tube, there must be some type of device to trap the total air flow, and there must be a flowmeter to act as the sensing instrument in place of the pressure transducer. Since the

¹This formula was obtained from Philip G. Hubbard, Ph.D., who is a Professor of Hydraulics, State University of Iowa.

signal from most flowmeters is, again, a voltage, the need for amplifiers and read-out systems is the same as discussed previously.

Face Masks. Discussion will be devoted later to the probability that face masks are the best choice of device for trapping expired air. If air leaks between the edge of the face mask and the subject's face, the air flow measure will not be accurate. The wide variability in the configurations of the human face suggests the need to have on hand the largest possible assortment of masks in order to fit most subjects. Also, to help eliminate this problem, Comroe (1950) suggests that a thin collar of rubber be glued to that part of the face over which the mask is placed.

Flowmeters. Van den Berg (1962) gives a comprehensive discussion of the advantages and disadvantages of various types of flowmeters. He concludes that flowmeters which are best for speech research are those which are designed upon the following principles: (1) The air flow is channeled through a tube which is constructed so as to create a very slight resistance to the flow. (2) A slight pressure increase on the input side of the resistance is created by the flow. (3) If the tube and resistance are properly constructed, the increase in pressure will be linearly related to the rate of air flow. (4) A pressure transducer may then be used to measure the pressure drop across the resistance, and that pressure transducer may be calibrated so that the instrumentation system will read-out in rate of air flow. The pneumotachograph described by Comroe (1950) is that type of instrument, and it, or modifications thereof, has been used recently by Isshiki and Ringel (1964), Kunze (1964), and others.

Some interest seems to be developing in the use of hot-wire anemometers for speech research. Van den Berg objects to the use of this type of instrument due to its limited frequency response. However, published specifications of commercially available hot-wire flowmeters suggest that their frequency response is acceptable for speech research in which there is no interest in the very rapid fluctuations in rate of air flow which are associated with laryngeal vibrations.

Without personal experience in using a hot-wire anemometer, the present speaker strongly favors the pneumotachograph because of its lower cost and its ability to detect inspiratory and expiratory air flow. Because of the inherent electronic complexity in the design of the hot-wire anemometer, its cost is almost twice that of a pneumotachograph combined with an associated pressure transducer. The hot-wire anemometer, which utilizes a thin wire as the sensing element, cannot detect direction of flow since cooling of the wire is insensitive to the direction of flow. On the other hand, a differential pressure transducer will record a pressure build-up on either the inspiratory or expiratory side of the thin wire mesh which is used as the resistive element in the pneumotachograph, and negative or positive voltages will reflect the direction of flow. Since the pneumotachograph appears to hold no disadvantages over the hot-wire anemometer for speech research, the former would seem to be the instrument of choice.

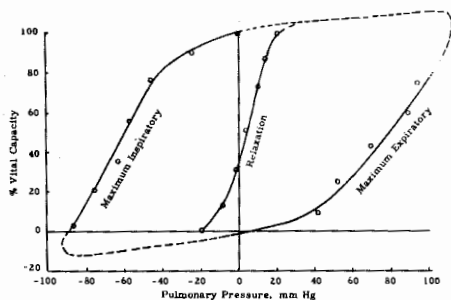

FIGURE 2. Diagram showing that maximum expiratory pressures which can be produced by the human respiratory system will vary as a function of lung volume (Fenn, 1954, p. 20). This diagram is reproduced with the permission of Wallace O. Fenn, Ph. D., and the School of Aviation Medicine, USAF Aerospace Medical Center (ATC), Brooks Air Force Base, Texas.

Physiological Variables

In addition to the varieties of instrumentation available and the limitations of that instrumentation which must be considered in planning study of intra-oral air pressure and air flow from the speech mechanism, there are certain physiological variables which also must be considered.

Pressure Volume Relationships. Curtis (1963) has discussed the pressure volume relationships of the human respiratory system. Figure 2 shows data published by Fenn (1954) which demonstrate that potential for developing expiratory pressure varies with lung volume. The maximum expiratory pressure curve shown indicates that as the lungs are deflated, the potential for producing expiratory pressure decreases.

Implications in Determining Oral Manometer Ratios. A basic assumption in the use of oral manometer ratios is that the subject is producing a maximum expiratory effort, or at least an equal expiratory effort, for the two pressure efforts. During these pressure efforts, it can be assumed that the airway between the lungs and oral cavity is open.²

Therefore, it can be assumed also that pressure within the respiratory system, the oral cavities, and connecting airway are equal. If the pressure volume relationships of the respiratory system shown in Figure 2 are not taken into account, the basic assumption that the subject is producing two equal expiratory efforts may be invalid. That is, it is necessary that lung volume be constant for the two pressure efforts. If lung volume is not constant for these two efforts, substantial variability in the two pressure readings may be observed because of the subject's inability to produce two equal pressure efforts at two different lung volumes.

When it is considered that this highly related variable of lung volume has not been controlled in the cleft palate research which has used oral manometer measures, it is surprising that these measures have been shown to be as predictive of palatal malfunction as reported. If subjects were instructed in such a

²The most frequently encountered circumstance in which this assumption cannot be made is described by Chase (1960) and Morris and Smith (1962) in which some cleft palate subjects produce buccal pressures by using tongue-palate contact rather than keeping the oral pharyngeal air-way open. Those authors' suggestion of a "vent" or "bleed" manometer to evacuate air from the oral cavity and thereby requiring the subject to use expiratory pressure seems to be a satisfactory method for eliminating this problem.

TABLE 1. Magnitudes of intra-oral air pressure associated with different types of consonant speech sounds in three positions in words as reported by Black (1950) with the pressure values converted from ounces per square inch of pressure to millimeters of mercury of pressure.

Type of Consonant Speech Sound	Initial Position		Medial Position		Final Position	
	Oz.in ²	mmHg	Oz.in ²	mmHg	Oz.in ²	mmHg
Voiced	30.2	97.5	26.2	84.6	23.7	76.5
Voiceless	42.2	136.3	38.9	125.6	37.9	122.4
Plosive	33.5	108.2	30.6	98.8	24.0	77.5
Continuant	39.3	126.4	30.9	99.8	30.6	98.8

Conversion factor: 1 mm Hg = 1333.2 dynes/cm²
 1 Oz. in² = 4309.2 dynes/cm²
 1 Oz. in² = 3.23

way that it could be assumed their lungs were maximally inflated prior to the pressure efforts, this variable could be assumed constant for the two pressure efforts.

Implications for Research. The data of Fenn (Figure 2) also show an important need for more research regarding intra-oral breath pressures associated with speech production. This graph suggests that slightly over 100 mm of mercury is the maximum amount of pressure which the respiratory systems of young adult males can produce.

Table 1 shows Black's data on intra-oral pressures during production of consonants as reported in ounces per square inch of pressure with the pressure values converted to millimeters of mercury. Note that with three exceptions the intra-oral breath pressures reported by Black routinely approximate or run higher than 100 mm of mercury. There is no reason to assume that the speech process taxes the respiratory system to its maximum. To the contrary, there is a strong suggestion that the speech process minimally taxes the respiratory system (e.g., Draper, Ladefoged, and Witteridge, 1959).

Consequently, there seems to be something inherently wrong in Black's data. He reports that his instrumentation was relatively crude, and it may be that his pressure measuring instrumentation was not calibrated appropriately, thus resulting in the spuriously high pressure values.³

Influence of Pressure into the Middle Ear. In using manometer ratios it is necessary to ask the cleft palate subject to expire maximally into the manometer thus building up relatively high pressures within the oral cavity, and if the velopharyngeal port is open, this pressure will exist in the nasal cavity during the nostrils' occluded effort. Spriestersbach and Powers (1959) indicate that the average manometer reading with the nostrils occluded of a group of cleft subjects who demonstrated palatal incompetence was 11 ounces per

³The recent research of Arkebauer (1964) and the apparently overlooked work of Malecot (1955) present intra-oral air pressure data during consonant sound production which are substantially below the pressure magnitudes reported by Black, and Arkebauer gives a relatively comprehensive discussion of other reasons why Black's data may be spuriously high.

square inch of pressure, while that measure for a group of subjects with functioning palates was 15.3 ounces per square inch. Those authors suggest that the difference between the mean pressures achieved by the two groups with the nostrils occluded was due to "sampling and experimental error rather than to an inherent difference in the blowing ability of the two groups."

In studying pressure volume relationships with physically normal and neuro-muscularly handicapped subjects at the Speech Research Laboratory, University Hospital School for Severely Handicapped Children, State University of Iowa, it is virtually impossible to get subjects to produce maximum efforts whenever maximum expiratory pressures are allowed to feed into the nasal cavities. Under such conditions, some normal subjects report that their reluctance to blow maximally is the result of their popping their ears. It seems likely that the data reported by Spriestersbach and Powers is the result of reluctance on the part of cleft children who have palatal incompetency to inflate their middle ears through the Eustachian tubes. With that portion of the cleft population which has palatal incompetence, there seems little likelihood of preventing this problem. Consequently, it should be expected that manometer measurements with cleft subjects which are made while the nostrils are occluded will probably be lower than would be expected of subjects who have palatal competence, and the necessity for using manometer ratios rather than absolute pressure measures in such tests is clearly indicated.

Respiratory Dead Space. As discussed previously, when air flow from the speech mechanism is measured, it is necessary to channel the total volume flow through some type of flowmeter. Face masks, mouth masks, or face masks which are partitioned to separate nasal and oral air flow may be used for this purpose. These masks have the obvious disadvantage of restricting somewhat the movement of the mandible and, therefore, they somewhat distort articulatory speech movements. Investigators may be inclined to attempt the use of other devices to trap air flow (e.g., larger masks which fit around the neck, helmets, etc.).

Comroe (1955) describes two types of respiratory dead space — anatomical and physiological dead space. In general, respiratory dead space is that volume of air in the respiratory system and respiratory airway where "no rapid exchange of O₂ and CO₂ occurs." This important physiological variable must be considered in design of research studies in which measurement of air flow from the speech mechanism over prolonged periods of time is necessary.

Comroe (1950) pointed out that adding dead space to anatomical and physiological dead space will have the effect of changing tidal breathing patterns of the subject since this addition requires the subject to breathe through more dead space to obtain ventilation. In combination with the emotional concomitant arising from a breathing situation which has been altered from the normal, the added dead space of a large face mask or head helmet may have more serious effects upon the behavior of the subject than restriction of jaw movements during speech. Comroe concludes that relatively small face masks are

probably the best device which can be used to trap expired air because of their relatively small amount of dead space.

Static Measures as Compared to Measures During Speech. As has been pointed out (Morris and Smith, 1962), the oral manometer and vital capacity measures which have been discussed are taken during relatively static conditions of expiratory efforts and not during speech activities. The extent to which such measures can be used to predict the ability of a patient to impound intra-oral air pressure during speech is questionable for some patients. It seems reasonable to assume that a select group of cleft palate speakers may achieve good palatal closure during a static expiratory effort and not do so during speech production when rapid movement of the palate is necessary. This assumption seems generally accepted, but the need for development of diagnostic techniques for assessing the cleft speaker's ability to generate and maintain intra-oral pressure during speech seems requisite to better understanding of the cleft problem.

Implications of Recent Research

As indicated in Footnote 3 of this paper, studies by Malecot (1955) and Arkebauer (1964) suggest that Black's data reflect spuriously high intra-oral air pressures during speech production. Moreover, those more recent data show a reversal of trends in peak pressures recorded for continuant consonants compared to stop consonants. That is, higher peak pressures were found associated with stop consonants.

Those data should not be interpreted as detracting from current beliefs that the inability to maintain intra-oral air pressure during speech is a paramount problem for the cleft speaker. As Arkebauer states, "Clinical management designed to enable cleft palate speakers to impound intra-oral air pressure during speech attempts has proven much too profitable to deny that aberrations of the aerodynamics of consonant sound production is a crucial contributing factor to the cleft problem" (p. 78). As Arkebauer points out, there has yet to be made available information regarding the total intra-oral aerodynamic energy necessary for consonant sound generation. Such information must include the potential and kinetic aerodynamic energy developed intra-orally. Obtaining that information would entail concomitant study of intra-oral air pressures developed over time and the amount of air flowing through the oral cavity. Once such information becomes available, an even better understanding of the cleft problem may be possible.

SUMMARY

This paper has presented a discussion of certain types of instrumentation, limitations of that instrumentation, and physiological variables which must be considered in planning clinical and research work utilizing measures of intra-oral air pressure and air flow from the speech mechanism. Also, the need to understand better the dynamics of intra-oral air pressure and expiratory air flow during speech production has been suggested.

As clinical and research work continues and more knowledge is gained regarding the intra-oral air pressures needed for speech sound production, it may be confirmed unequivocally that inability to generate intra-oral aerodynamic energy is the major cause of articulation problems in the cleft palate population.

REFERENCES

- ARKEBAUER, H. J., A study of intra-oral air pressures associated with production of selected consonants. Ph.D. dissertation, State University of Iowa (1964).
- BLACK, J. W., The pressure component in the production of consonants. *J. Speech Hearing Dis.*, **15**, 207-210 (1950).
- BUNCKE, H. J., Manometric evaluation of palatal function in cleft palate patients. *Plastic and Reconstructive Surgery*, **23**, 148-158 (1959).
- CHASE, R. A., An objective evaluation of palatopharyngeal competence, *Plastic and Reconstructive Surgery*, **23**, 23-39 (1960).
- COMROE, J. H., JR. (Ed.), *Methods in Medical Research*, **2**. Chicago: The Year Book Publishers Inc. (1950).
- CURTIS, J. F., Normal Speech Processes, (paper to be published in NIDR Conference Monograph).
- DRAPER, M. H., LADEFOGED P., and WHITTERIDGE, D. Respiratory muscles in speech. *J. Speech Hearing Res.*, **2**, 16-27 (1959).
- FENN, W. O., In W. M. Boothby (Ed.), *Handbook of Respiratory Physiology*. Randolph Field, Texas: USAF School of Aviation Medicine (1954).
- IBERALL, A. S., Attenuation of oscillatory pressures in instrument lines. *Statham Instrument Notes*, **22** (1952).
- ISSHIKI, N., and RINGEL, R., Air flow during the production of selected consonants. *J. Speech Hearing Res.*, **7**, 233-244 (1964).
- KUNZE, L. H., Evaluation of methods of estimating sub-glottal air pressure. *J. Speech Hearing Res.*, **7**, 151-164 (1964).
- MALECOT, A., An experimental study of force of articulation. *Linguistica*, **9**, 35-44 (1955).
- MCGLONE, R. J., and HARDY, J. C., Design of instrumentation for measuring intra-oral, intrathoracic, and intrapulmonic air pressures during speech and determination of the response characteristics of that instrumentation. Complete Study Report No. I. A., 1., Speech Research Laboratory, University Hospital School, State University of Iowa.
- MCWILLIAMS, B. J., Articulation problems of a group of cleft palate adults. *J. Speech Hearing Res.*, **1**, 68-74 (1958).
- MORRIS, H. L., and SMITH, JEANNE K., A multiple approach for evaluating velopharyngeal competency. *J. Speech Hearing Dis.*, **27**, 218-226 (1962).
- MORRIS, H. L., SPRIESTERSBACH, D. C., and DARLEY, F. L., An articulation test for assessing competency of velopharyngeal closure. *J. Speech Hearing Res.*, **4**, 48-55 (1961).
- POWERS, G. R., Cinefluorographic investigation of articulatory movements of selected individuals with cleft palates. *J. Speech Hearing Res.*, **5**, 59-69 (1962).
- ROUSE, H., and HOWE, J. W., *Basic Mechanics of Fluids*. New York: John Wiley & Sons, Inc. (1953).
- SPRIESTERSBACH, D. C., Effect of orofacial abnormalities on the speech process (paper to be published at the NIDR Conference Monograph).
- SPRIESTERSBACH, D. C., DARLEY, F. L., and ROUSE, V., Articulation of a group of children with cleft lips and palates. *J. Speech Hearing Dis.*, **21**, 436-445 (1956).
- SPRIESTERSBACH, D. C., and POWERS, G. H., Articulation Skills, velopharyngeal closure, and oral breath pressure of children with cleft palates. *J. Speech Hearing Res.*, **2**, 318-325 (1959).
- STEDMAN, C. K., Alternating flow of fluids in tubes. *Statham Instrument Notes*, **30** (1956).
- SUBTELNY, J. D., and SUBTELNY, J. D., Intelligibility and associated physiological factors of cleft palate speakers. *J. Speech Hearing Res.*, **2**, 353-360 (1959).
- VAN DEN BERG, J., Modern research in experimental phoniatrics. *Folia Phoniatica*, **14**, 81-149 (1962).

RESEARCH TECHNIQUES AND INSTRUMENTATION: EMG

FRANKLIN S. COOPER

Haskins Laboratories, New York, New York

Electromyography (EMG) is a technique especially suited to the analysis of skilled movements in general, and of speech in particular. Its particular merit is that it provides direct information about the speech gesture in its natural units. The sound spectrogram and x-ray motion picture, though valuable, give only indirect and highly encoded answers to the essential questions about speech: what muscles are contracting, and when? Moreover, since the muscular contractions reflect so directly the motor commands carried by neural impulses, EMG enables us to look upstream toward the speaker's brain for clues to the organization of the neural machinery that generates spoken language.

This paper consists of a brief account of the underlying phenomena and the means by which they can be observed instrumentally, examples of the use of electromyography in speech studies (drawn largely from the work of colleagues at Haskins Laboratories¹), and comments on the special opportunities and problems associated with the use of EMG for research on speech.

Muscle Potentials and Their Recording.

EMG provides graphic information about the electrical activity which accompanies muscle contraction. The basic entity in the neuro-muscular mechanism is neither the whole muscle nor the individual muscle fibre, but a structure of intermediate complexity called the motor unit. This comprises, in the small-to-medium-size voluntary muscles used for speech, a single neuron and the group of a hundred or so muscle fibres to which it is connected by its motor end plates. A neural impulse arriving at one of these end plates excites a wave of depolarization that sweeps along the muscle fibre, somewhat like a grass fire, at a few meters per second. The local activity, corresponding to the flame in the analogy, is a flow of electric current near the depolarized part of the membrane. The strength of the ionic currents decreases with the distance from the muscle fibre, though electrical effects are still detectable at several centimeters.

¹More extensive accounts of this work and the names of colleagues responsible for it are indicated in the References.

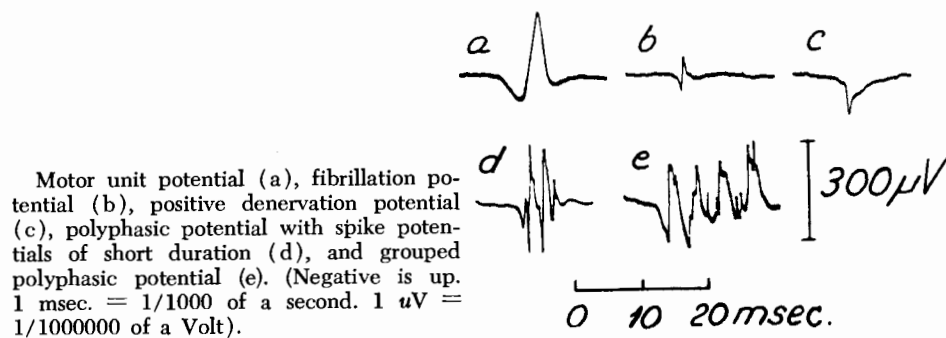

FIGURE 1. Electrical activity of muscle as recorded from a needle electrode by photographing the trace on a cathode-ray tube. (From Buchthal)

If two wires are placed with their exposed ends close to each other and to the muscle fibre, momentary differences in the electric potentials at the wires can be observed when the wave of activity sweeps past. The whole event, which takes but a few milliseconds, can be displayed on the face of a cathode-ray tube, and gives a trace similar to the one shown in Figure 1(a). The entire process of stimulation by the nerve and response by the muscle may be repeated some tens of times per second.²

Much of the extensive literature on EMG³ deals with correlations between the detailed characteristics of muscle potentials and various pathological conditions of either the muscle fibre or its innervation. Some examples of atypical spike potentials are shown in Figure 1(b-e).

The effect of level of effort (Rosenfalck, 1960) in a normal muscle is illustrated by the oscillographic recordings of Figure 2. The top trace shows several muscle action potentials occurring in rapid succession, one at each activation of the particular muscle fibres near the needle electrode. The middle trace shows that a slight increase in contraction involves a second motor unit, and the bottom line, where the individual motor unit spikes are no longer distinguishable, shows the trace for a stronger contraction. Clearly, the total amount of electrical activity increases with the forcefulness of the contraction; indeed, force and electrical activity are proportional to each other, to a first approximation.

²For additional descriptions and quantitative data about conduction velocities, innervation ratios, etc., see Buchthal and Faaborg-Andersen.

³An extensive "Bibliography on Electromyography" as of 1960, arranged by subjects and authors, has been made available by DISA Elektronik A/S Herlev, Denmark.

When the response of the muscle as a whole is of primary interest, as it usually is in research on speech, a simple indication of the total electrical activity would be preferable to much fine detail. Such an indication can be obtained by using larger electrodes that record directly from the whole muscle, rather than from the very limited zone around a needle tip. The larger electrodes may be placed on the surface of the skin if the muscle is not too deep. These surface electrodes are affected by the waves of depolarization in muscle fibres just as are needle electrodes but, since they are almost equally exposed to many fibres and to a greater length of each fibre, the electrode potential is a summation over both space and time; thus, EMG recordings from surface electrodes do not show the spike potentials characteristic of single motor units but rather a less rapid fluctuation of potential attributable to the activity of many motor units.

EMG and Speech Research: Needle Electrodes

Since EMG techniques for studying muscle pathology have usually employed needle electrodes, it was to be expected that these same techniques would be used in investigating speech articulation, even though a different kind of information about muscle activity was being sought. Some of the advantages and limitations attendant upon the use of needle electrodes can be indicated by examples of such use.

Ladefoged (1962) and his colleagues at the University of Edinburgh have examined the activity of the subglottal system from the point of view of Stetson's hypothesis that rhythmic contractions of the intercostal muscles are the significant counterparts of spoken syllables. Their EMG recordings, taken during an ongoing utterance, showed a transfer of activity from the external

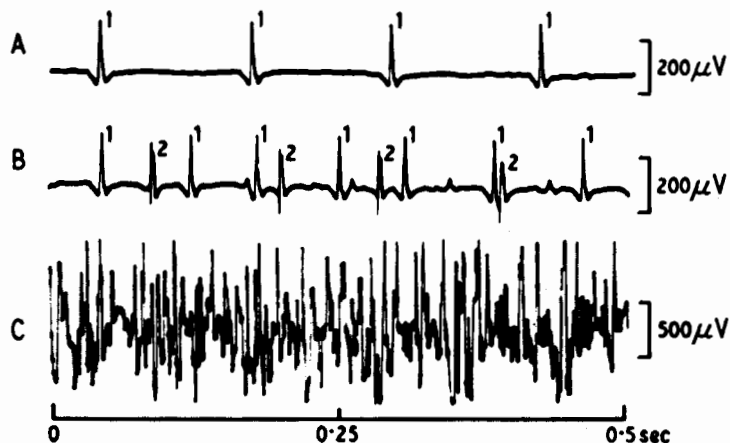

Muscle action potentials recorded at weak effort (A and B) and strong effort (C)

FIGURE 2. Effect of level of effort in normal muscle. (From A. Rosenfalck)

to the internal intercostals as the subglottal air pressure shifted from overpressure to underpressure. In addition, there were bursts of activity superimposed on the gradually increasing signal from the internal intercostals. Though these bursts were not correlated in a simple way with the individual syllables of the utterance, there was some correspondence with the stress pattern.

Figure 3 gives the data and their analysis for a single sentence. A needle electrode in the internal intercostals picks up mainly the activity of a single motor unit firing between 10 and 30 times per second. The derived curve at the bottom of the figure shows the instantaneous repetition rate of the motor unit spikes. The variations in rate corresponds roughly to the stress pattern of the sentence. This is an example of the detail provided by a needle electrode and of one quantitative use that can be made of it. The reduction of the experimental data is laborious, and any error in identifying or measuring the position of a single pulse would introduce a substantial perturbation in the final curve; furthermore, interpretation of the data involves the implicit assumption that all of the motor units would, if recorded, show similar variations in firing rate. A virtue of the method is, of course, that needle electrodes permit unambiguous identification of the muscle from which the data are being taken.

Another illustration is provided by the experiments of Faaborg-Andersen (1957) on the behavior of the intrinsic muscles of the larynx during phonation.

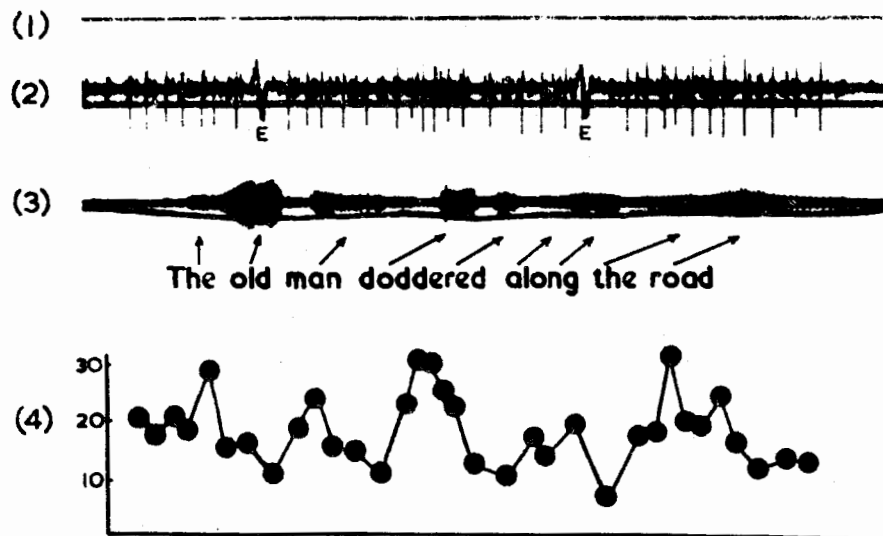

Internal intercostal activity during speech. (1) Time marker 1/10 and 1/100 seconds. (2) Internal intercostal action potentials (electrical activity associated with the action of the heart indicated by E). (3) Microphone record. (4) Instantaneous frequencies of the single motor unit recorded in (2) in impulses per second.

FIGURE 3. Electrical activity of internal intercostal muscle during speech, as recorded from a needle electrode. (From Ladefoged)

Electrical activity in the left vocal muscle during phonation with simultaneous microphone recording. A. The action potential pattern. B. The mean action potential amplitude. C. Microphone recording. Phonation: "e". Frequency 285 c.p.s. Patient no. 56, a 64 year old woman with the right vocal cord immovable in paramedian position. The left vocal cord was normally movable.

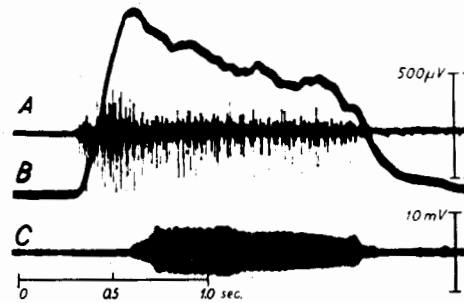

FIGURE 4. Electrical activity of an intrinsic muscle of the larynx during phonation, as recorded from a needle electrode. (From Faaborg-Andersen)

Figure 4 shows the activity in the left vocalis muscle during a brief phonation, as recorded from a small needle electrode. So many motor units are active that it is not possible to separate and count their spikes (Trace A), though the temporal course and general magnitude of the activity is evident. This aspect is made explicit in Trace B which shows a running average of the signal from the electrode. The temporal relationship between Traces A and B and Trace C are typical: muscle activity precedes the acoustic signal, in this case by some tenths of a second.

The series of studies from which this example was taken explores the coordinated activities of most of the intrinsic laryngeal muscles in respiration and in phonation at different pitches, intensities and registers. The recordings were made with needle electrodes and a DISA electromyograph, which provides three channels of photographic registration from three cathode-ray tubes. Special input amplifiers are required to avoid "loading" the electrodes, since the latter have, typically, an impedance of a few hundred thousand ohms. Careful shielding is required to avoid extraneous voltages on such high-impedance leads, though noise problems are not severe in EMG since signal levels are usually rather high. Cathode-ray tubes and photographic recording are used to obtain a high frequency response.⁴ The recording session can be monitored by a second set of oscilloscopes and a loud speaker; even so, photographic recording is inconvenient and the limitation to three channels is restrictive. It would, of course, be possible at some further expense to have more channels and to avoid photographic processing by utilizing the ultraviolet recording papers and optical galvanometers that are now available.

Surface Electrodes

Considerations of the kind mentioned above have led a number of investigators to use surface electrodes and penwriters, particularly when their research needs could be met by measurements of overall muscle activity. This was the case in the research undertaken at Haskins Laboratories. The initial experi-

⁴Buchthal recommends a frequency response good to 10 kilocycles.

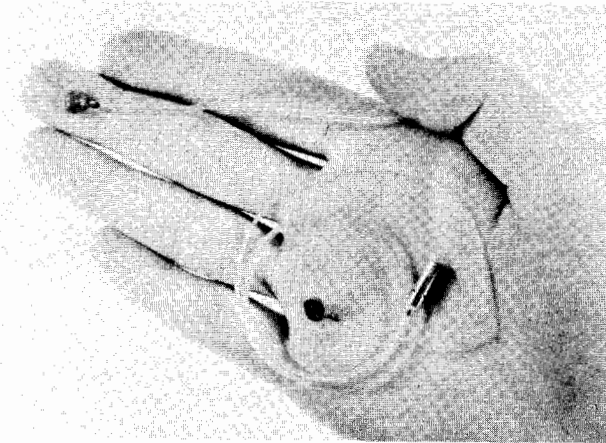

FIGURE 5. Suction electrodes developed for electromyographic studies of speech.

ments employed the techniques and surface electrodes described by J. F. Davis (1952) of McGill University. Although surface EMG proved suitable, it was soon necessary to develop a special electrode system and make use of magnetic recording to store data for later analysis.

The primary aim of the work at Haskins Laboratories has been to gain an understanding of the distinctive components of speech gestures and their relationships to the linguistic units of normal speech. Thus, the chief interest has been in gross aspects of the activity, primarily in the supraglottal region and at the larynx. The obvious need for electrodes on the tongue and inside the mouth, and the desirability of simultaneous recordings from several locations, led to the development of a system using small vacuum cups as electrodes.⁵

Figure 5 shows a complete electrode assembly and also an electrode attached to a finger. The electrodes are silver jewelry beads about a quarter of an inch in diameter that have been cut in half and fitted with side tubes which can be inserted into small-diameter Silastic tubing. A stranded steel wire inside the tubing connects the electrode to a brass plug at the other end. This plug makes both vacuum and electrical connections to the manifold, shown in Figure 6. The manifold is connected by a vacuum line to a five-gallon jug that is pumped continuously. The electrical connections are carried from the manifold through shielded cables to the preamplifiers of a modified electroencephalograph.

These small suction electrodes have proved to be very satisfactory. They adhere well on the tongue, inside the mouth, or on the face; they show negligible movement artifact, at least as seen through 20-cycle high-pass filters; and, they offer very little hindrance to normal speech. The only preparation that is necessary for placement of the electrode on facial skin is a brief scrub-

⁵Harris, K.S., Rosov, R., Cooper, F.S., and Lysaught, G.F. "A Multiple Suction Electrode System." (Submitted for publication in *Electroencephalography and Clinical Neurophysiology*.)

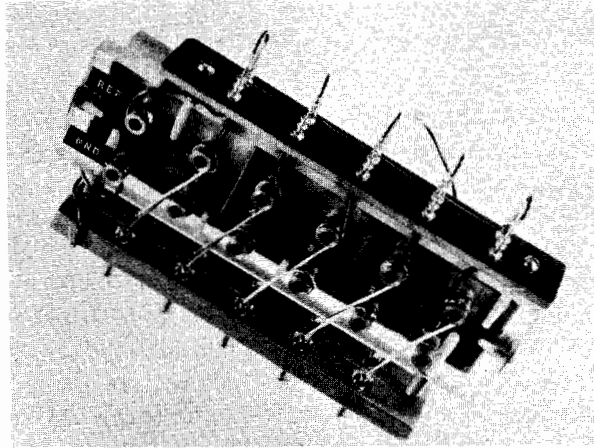

FIGURE 6. Vacuum manifold and electrical connections for suction electrodes.

bing with a gauze pad dipped in alcohol, followed by the application of a little electrode jelly; no site preparation is, of course, necessary on mucosa. The electrode resistance on either skin or mucosa is quite low, usually in the range of 1000-2000 ohms. Typical muscle potentials as picked up by these electrodes are several hundred microvolts at least, so that the subject need not be put in a shielded room even in a location that has high-level radio interference. We have used the electrodes either as bipolar pairs or singly, with a reference electrode on an ear lobe.

The EMG recordings are made with an eight-channel Edin electroencephalograph, modified to eliminate components below 20 cycles and to have a paper speed matching that of the standard sound spectrogram, namely, five inches per second. Two channels are used for each electrode position, one for the muscle potential itself and the other for an integrated trace. One channel is regularly reserved for a vibration pickup (throat microphone) located at the larynx and another is often used to record from a pressure transducer. Magnetic tape recordings are made of what the subject says, the output from the larynx microphone, and the muscle potentials from one of the electrode locations. This procedure has permitted us to experiment with integrated traces derived from various frequency bands in the myographic signal that lie above the frequency limit of the penwriter (approximately 100 cps), and also to correlate EMG traces with sound spectrograms.

The system has been quite satisfactory insofar as the individual channels were concerned, but more channels have often been needed: moreover, it would have been most helpful to have captured the raw data in a form that would have permitted detailed analysis in various ways. Hence, we are now rebuilding the system to use magnetic tape recording as the primary means of data collection. The penwriters will be used to monitor the recording session and, later, to display data from selected channels of the magnetic tape

recording. Figure 7 shows the principal components of the system. The need for automated data reduction has been thoroughly impressed on us even though we have collected and analyzed only limited amounts of data with our original system.

Experiments on Labial Stop and Nasal Consonants.

The kinds of experiments for which this equipment was designed can be illustrated by early studies (Harris, Lysaught, and Schvey, 1962) of the component gestures that serve to distinguish the bilabial stop and nasal consonants /p,b,m/, as in the words "peak, beak, meek." The whole articulatory apparatus is, of course, involved in producing these sounds; however, it is the gestures at lips, velum, and glottis that are likely to be decisive in determining which of the three sounds was produced in a particular instance. It was possible to find specific electrode placements near the lips that are diagnostic, one for lip closure and the other for lip opening. These electrode positions are indicated in Figure 8 and myographic records from them are shown in Figure 9 for the stops /p,b/ in nonsense utterances. The vibrations at the larynx, as shown by the bottom trace, provide convenient timing indications for the moments of lip closure and lip opening. The electrical activity at the upper lip electrodes, presumably due principally to the Orbicularis oris muscle, starts well before lip closure but reaches a peak of activity at just about the moment the lips make contact. The activity at the lower electrodes, due presumably to the Quadratus labii inferioris, comes about 80-100 msec later in time and reaches

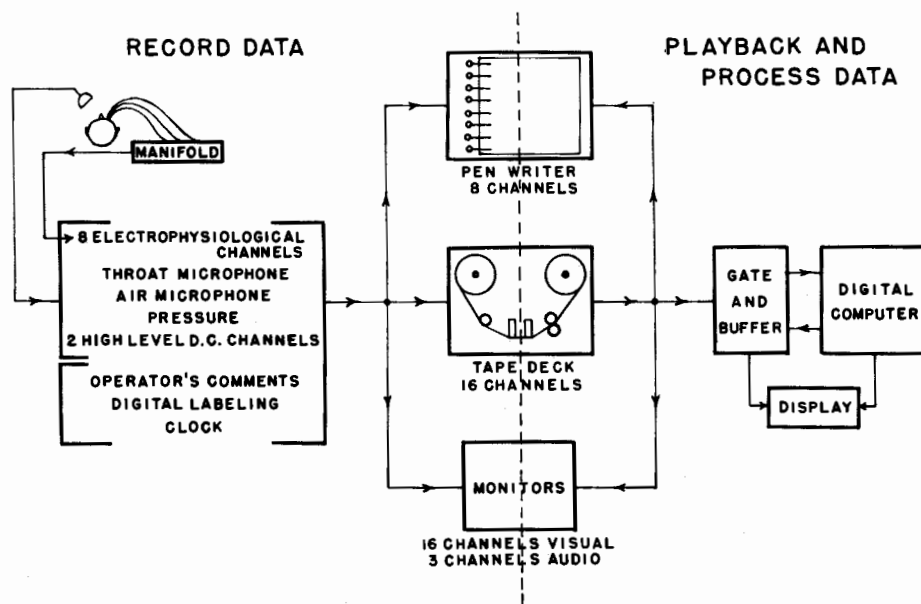

FIGURE 7. System for collecting and analyzing physiological and acoustical data about speech.

its peak at just about the moment of lip opening. This same relationship holds for both /p/ and /b/ in all four utterances.

The events at the glottis are clearly different for /b/ and /p/, as we might suppose; that is, for /b/ the vocal cord vibrations continue through most or all of the lip occlusion, while for /p/ there is an abrupt cessation of vocal cord activity at the moment of lip closure, and vibration is not resumed until appreciably after lip opening. Pressure measurements and transillumination of the glottis both indicate that for /p/ the vocal cords are drawn quickly apart and held so throughout the interval of closure at the lips.

It is, however, instructive to examine the lip gestures for /p/ and /b/ to see if there are significant differences in that location also. Figure 10 shows the relative amplitudes of the integrated myographic tracings for a total of 360 utterances produced by five subjects. There are differences of the order of 20% between /p/ and /b/; however, an examination of the spread of the amplitude distributions, shown in Figure 11, leads one to conclude that there is so much overlap that reaching a decision about any particular utterance on the basis of its magnitude alone would be extremely chancy. Hence, in a practical sense and for the quick categorical assignments so necessary in speech communication, one can say that the lip gestures are the same and the distinctive difference between /p/ and /b/ is to be found at the glottis.

What can be said about /m/? The glottal activity is the same as for /b/, and the lip gestures are very similar to those for both /p/ and /b/; however,

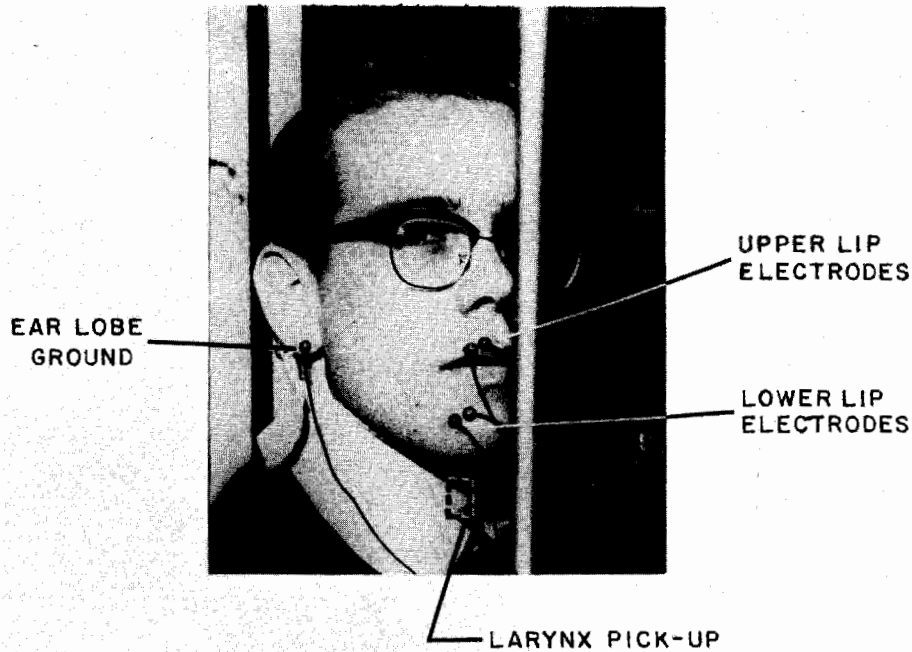

FIGURE 8. Placement of suction electrodes and larynx pick-up for experiments on lip activity in articulating the labial stop and nasal consonants.

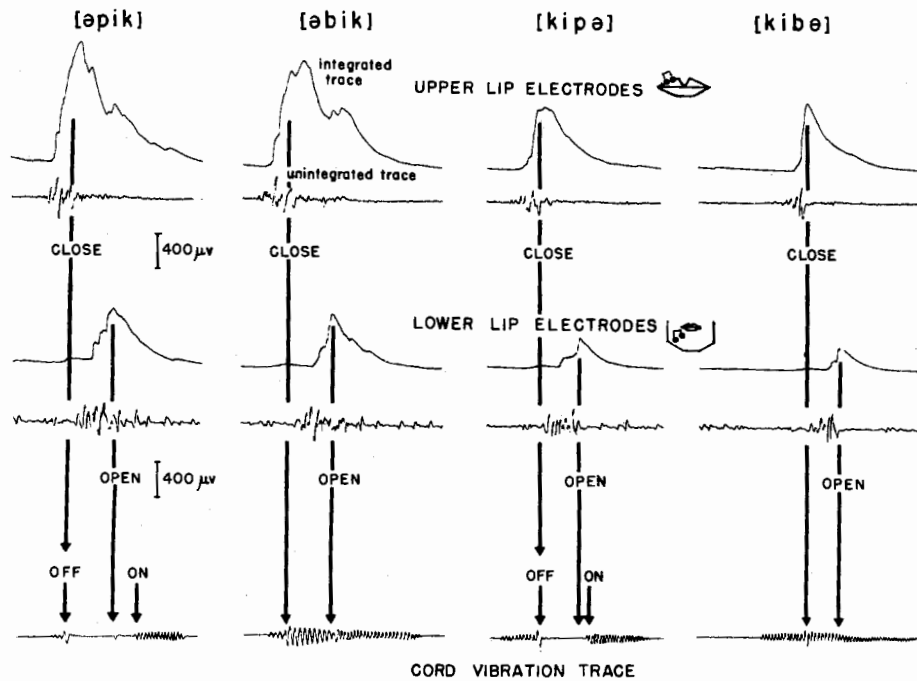

FIGURE 9. Electromyographic recordings (both direct and integrated) from the electrode locations shown in Figure 8; also, recordings of the vibrations at the larynx.

the activity at the velum is not at all similar. Figure 12 shows the various electrode placements used in searching for EMG signals that would correlate closely with velar closure. Most of the placements showed activity during speech, but only those on the posterior soft palate near the midline gave all-

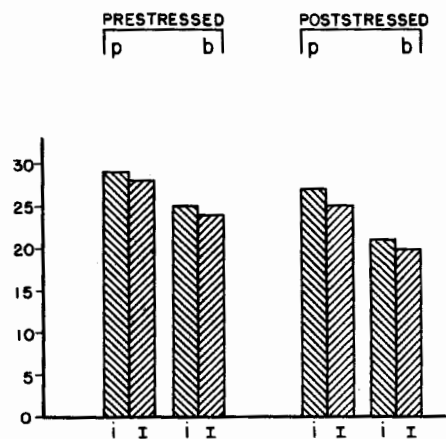

FIGURE 10. Peak amplitudes of integrated EMG traces from upper lip electrodes. The amplitudes were normalized for each subject and averaged for each utterance type.

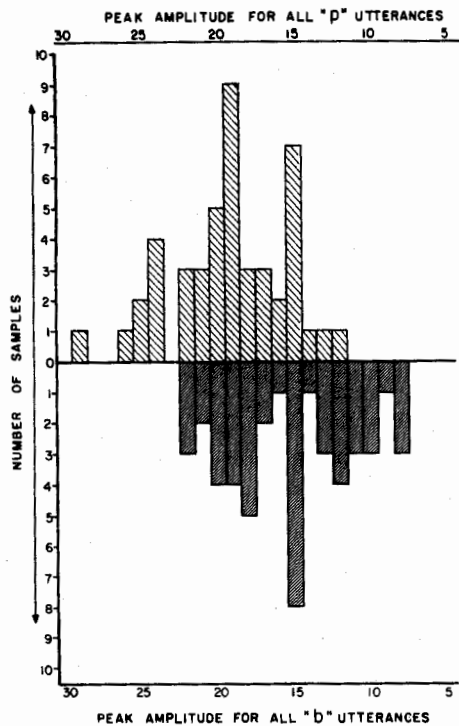

FIGURE 11. Distribution of peak amplitudes of the kind shown in Figure 10 for all /p/- and /b/-utterances for a single subject (J. B.)

or-nothing potentials that correlated with closure.⁶

(This would, of course, correspond to oralization in descriptive terms; none of the four subjects showed distinctive activity corresponding to nasalization.)

Two examples of activity at the velum and upper lip are shown in Figures 13 and 14. For the word "apple", there is velar activity (oralization) throughout the utterance, with an extra twitch on the velum at about the same time that the lips close for /p/; for "ample", there is rather little velar activity during the initial vowel, but then a sharp burst of activity in the middle of the closure period, signalling the shift from nasal to oral manner for the second member of the consonant cluster.

Figure 15 shows composite electromyograms for the utterances /dæpəl/ and /dæmpəl/ as recorded from electrodes on the velum and posterior pillar. For /dæpəl/, there is a surge of activity on the velar electrode to oralize the initial /d/, and it continues at a lower level throughout the utterance. For /dæmpəl/, this initial surge dies away for the /m/, but then there is a marked burst of activity for the /p/-member of the cluster. This occurs at very nearly the same moment that voicing stops, about the middle of the occlusion at the lips. The vertical line shows the offset of voicing, and was the time marker

⁶Fritzell, using needle electrodes in the lateral wall of the epipharynx, found electrical activity in both the tensor and levator muscles that correlated closely with the oral/nasal features of connected speech.

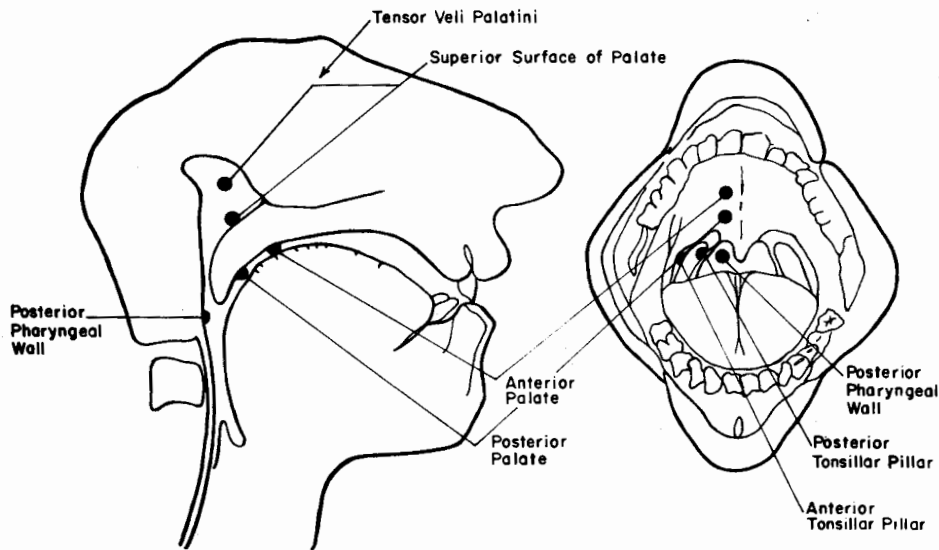
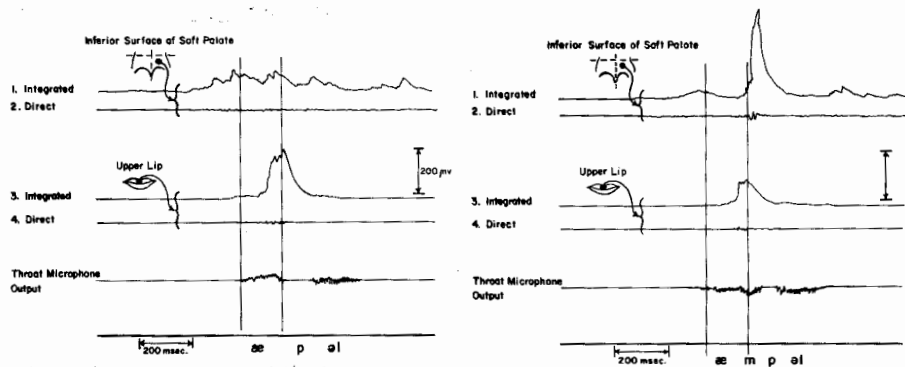

FIGURE 12. Electrode placements used in searching for electromyographic signals that correlate closely with velar closure.

used in superimposing the traces. The posterior pillar electrode shows activity that is partially, but not so closely, correlated with velopharyngeal closure. These sets of superimposed traces indicate the kind of utterance-to-utterance variability that one encounters.

The experimental results of these pilot studies can be summarized by noting the /p/, /b/, and /m/ have in common an almost identical set of gestures at the lips; that /p/ is distinguished by a devoicing gesture at the glottis; and that /p/ and /b/ are distinguished from /m/ by identical oralizing gestures at the velum. This does not differ very much from the conventional phonetic description — indeed, it would have been surprising and distressing if it had



FIGURES 13 and 14. Electromyographic recordings from soft palate and upper lip for the words "apple" and "ample." The throat microphone traces serve to identify the moments of vowel onset and lip closure.

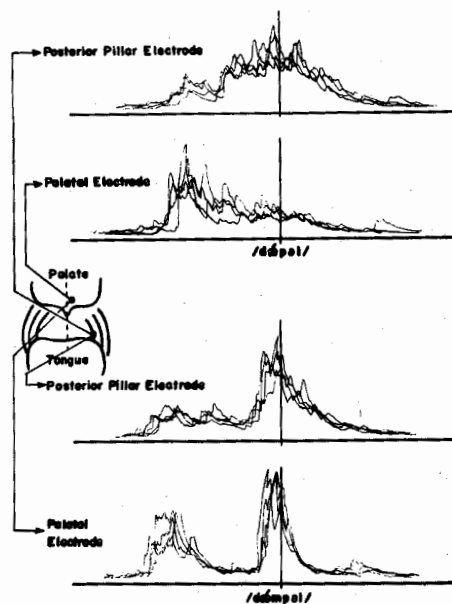

FIGURE 15. Superimposed EMG traces from electrodes on the velum and posterior pillar for the two utterances /dæpəl/ and /dæmpəl/.

—though the emphasis is different and the relationship between voiced and lax articulation is clarified. The main point is that the description is directly in terms of essentially all-or-none actions by specified parts of the articulatory apparatus. One can infer, at the neural level, an equally simple pattern of motor commands that correspond to the familiar dimensions of place and manner.

Working Hypothesis

It is an open question whether or not the preceding simplified description in terms of neural motor commands to component parts of the speech apparatus can be extended to all the sounds of the language (Harris, 1963a). A study of final consonant clusters containing /f/ suggests an affirmative answer (MacNeilage, 1963b). Some recent experiments on vowels and dental consonants (MacNeilage, 1963c, d; Harris, 1963) have given distinctive electromyographic records from electrodes on the tongue; however, the results elude so simple an interpretation, either because the electrodes fail to resolve the signals from adjacent muscles or because the relevant pattern of activation is inherently complex.

The practical problem here, as in much research, is to delimit the experimental measurements to those most likely to yield a useful model of the system. A most promising basis for such a model appears to lie in the motor command aspects of speech production (Liberman, Cooper, Harris, and MacNeilage, 1962; Cooper, Liberman, Harris, and Grub, 1958; Lisker, Cooper, and Liberman, 1962). The research of the Haskins group is aimed primarily at finding out how far it is possible to go in finding simple, direct correlations between the component gestures and the phonemic units of normal speech. We hope and

believe that this kind of normative data, and the techniques for getting it, will be relevant also to investigations of defective speech.

The special relevance of EMG as a technique for the study of speech, mentioned at the beginning of this report, has its basis, therefore, not only in the fact that EMG provides a direct measure of muscle activity, but also in the probability that the spoken language is so organized that it is produced by putting together simple combinations of component gestures, and that some of these component gestures, like the ones that distinguish /p/, /b/, and /m/, are themselves quite simple.

In short, EMG as a tool is matched to its task – but even a suitable tool needs guidance. An important part of that guidance can come from a knowledge of the acoustic cues that carry the main load of letting the listener know what sounds were intended by the speaker (Liberman, 1957 and 1959). Both the sounds of speech and the gestures for producing it contain much that is irrelevant for the listener, and private to the speaker. Speech is, for each of us, a very private affair – no one else cares how it is made, or heard, anymore than he cares whether personal savings are invested in real estate or stocks or yachts; the only requirement is that external transactions be conducted in the common currency. This currency consists of the acoustic cues carried in the speech waveform; however, it can be specified not only in terms of these acoustic cues but also of their counterparts in the spectrogram, in the x-ray movie, or in the EMG. There is no requirement that the total acoustic signal, or its counterparts, should be the same for all normal speakers – indeed, wide variations are to be expected – but only that all speakers should use the same cues. Moreover, the cues should be essentially the same in cleft palate speech and in normal speech, though again their counterparts may differ markedly, or be hidden by irrelevant differences.

The working hypotheses sketched above may be put briefly as the set of assumptions (a) that a useful model for speech can be based on the role of motor commands in articulation, (b) that EMG is an especially appropriate tool for finding correlations between component gestures and phonemic units, (c) that knowledge of the acoustic cues can guide the experimentation and keep it within practical limits, (d) that normal and cleft palate speech must have much in common at the level of acoustic cues if cleft palate speech is to be intelligible, and (e) that information about normal speech, and the research techniques used to obtain that information, will be directly relevant to the problems of cleft palate speech.

EMG Techniques: Prospects and Conclusion

Various EMG techniques used in speech research have been described in terms that might seem to imply no complications and no remaining problems. Not so; for even if all phones could be characterized as simply as those that have been discussed, many of the component gestures have yet to be isolated and measured. There are technical problems as well. Several parts of the speech apparatus, notably the tongue, have a number of overlapping muscles

and this poses the question of how to allocate measured potentials to the proper muscles. There may be ways to arrive at an answer: for one thing, a pair of electrodes gives maximum response for those muscle fibres that are parallel to the line through the electrodes; for another, the muscles nearest the electrodes will typically give the largest potentials and the highest frequency components; and, for a third, multiple electrodes and correlation techniques should help to sort out the potentials from adjacent muscles. In many locations, needle electrodes can also be used either to identify the active muscle or to confirm inferred assignments; likewise, a combination of electrical stimulation and EMG recording may be useful in making these assignments.

Finally, it should be said that we are not recommending EMG as an exclusive tool: the objective in research on speech, as in all research, is to learn about the phenomenon by any means. The trained ear, reinforced by the sound spectrograph, can be extremely useful in identifying the key elements in a speech event; x-ray motion pictures and direct photography of the vocal cords both yield valuable insights in a very literal sense; and, pressure, flow, and vibration measurements can also provide essential information. We are employing most of these techniques and find them useful. Even so, we feel that EMG holds the principal place as a tool with special relevance for the study of speech.

It is a pleasure to acknowledge that major support for the research reported here is being provided by a research grant from the National Institute for Dental Research, National Institutes of Health.

REFERENCES

- BUCHTHAL, F., *An Introduction to Electromyography*. Gyldendal, København (1957).
- COOPER, F. S., LIBERMAN, A. M., HARRIS, K. S., and GRUBB, P. M., Some input-output relations observed in experiments on the perception of speech. *Proceedings of the Second International Congress On Cybernetics*, Namur, Sept. (1958).
- DAVIS, J. F., *Manual of surface electromyography*. Allan Memorial Inst. Psychiatry, McGill Univ., Montreal (1952).
- FAABORG-ANDERSEN, K., Electromyographic investigation of intrinsic laryngeal muscles in humans. *Acta Physiologica Scandinavica* 41, Supplementum 140, Copenhagen (1957).
- FRITZELL, B., An electromyographic study of the movements of the soft palate in speech. *Folia phoniat.*, 15, 307-311 (1963).
- HARRIS, K. S., Behavior of the tongue in the production of some alveolar consonants. *J. acoust. Soc. Amer.*, 35, 784 (A) (1963).
- HARRIS, K. S., LYSAUGHT, G. F., and SCHVEY, M. H., Experimental studies of the production of oral and nasal labial stops. (in preparation).
- HARRIS, K. S., ROSOV, R., COOPER, F. S., and LYSAUGHT, G. F., A multiple suction electrode system. (Submitted for publication in *Electroencephalography and Clinical Neurophysiology*.)
- HARRIS, K. S., SCHVEY, M. H., and LYSAUGHT, G. F., Component gestures in the production of oral and nasal labial stops. *J. acoust. Soc. Amer.*, 34, 743 (A) (1962).
- LADFOGED, P., Sub-glottal activity during speech. In *Proceedings of the Fourth International Congress of Phonetic Sciences, Helsinki, 1961*, Mouton & Co., The Hague (1962).
- LIBERMAN, A. M., Some results of research on speech perception. *J. acoust. Soc. Amer.*, 29, 117-123 (1957).
- LIBERMAN, A. M., INGEMANN, F., LISKER, L., DELATIRE, P., and COOPER, F. S., Minimal rules for synthesizing speech. *J. acoust. Soc. Amer.*, 31, 1490-1499 (1959).

- LIBERMAN, A. M., COOPER, F. S., HARRIS, K. S., and MACNEILAGE, P. F., A motor theory of speech perception. *Proceedings of the Speech Communication Seminar*, Royal Institute of Technology, Stockholm, Sept. (1962).
- LISKER, L., COOPER, F. S., and LIBERMAN, A. M., The uses of experiment in language description. *WORD* 18, 82-106 (1962).
- LYSAUGHT, G. F., HARRIS, K. S. and ROSOV, R., Electromyography as a speech research technique with an application to the labial stops. *J. acoust. Soc. Amer.*, 33, 842 (A) (1961).
- MACNEILAGE, P. F., Motor patterns of speech production. *J. acoust. Soc. Amer.*, 35, 779 (A) (1963a).
- MACNEILAGE, P. F., Electromyographic and acoustic study of the production of certain final clusters. *J. acoust. Soc. Amer.*, 35, 461-463 (1963b).
- MACNEILAGE, P. F., and SHOLES, G. N., Electromyographic study of the tongue during vowel production. *J. acoust. Soc. Amer.*, 35, 783 (A) (1963c).
- MACNEILAGE, P. F., and SHOLES, G. N., Electromyographic study of timing in vowels. *J. acoust. Soc. Amer.*, 35, 1889 (A) (1963d).
- ROSENFALCK, A., Evaluation of the electromyogram by mean voltage recording, in *Medical Electronics*, Smyth, C. N., ed. Charles C. Thomas, Springfield, Illinois (1960).